



Forage harvesters

JAGUAR

880 870 860 850 840

CLAAS



The JAGUAR. The secret of its success.

Unstoppable: Making improvements where they have the greatest impact.

The JAGUAR allows you to keep operating costs down. Its strengths lie in its economical fuel consumption, its many operator assistance systems, the outstanding forage quality it produces and its high reliability. It all adds up to an investment that pays.



Throughput.

Front attachments, crop flow and the transverse engine are optimally matched to produce outstandingly high throughput – the result of more than 50 years of experience in forest harvester technology.

Chop quality.

The new V-FLEX chopping cylinder, the V-MAX and the V-CLASSIC cylinder deliver precise chop quality. Optimal kernel processing is ensured by the MULTI CROP CRACKER system. The results can then be checked extremely quickly by using CLAAS connect for kernel processing analysis.

Efficiency.

Efficiency is improved both by innovative assistance systems, such as CEMOS AUTO PERFORMANCE, and by an intelligent drive system. Greater working widths also contribute to the significantly enhanced costeffectiveness of these machines.

Comfort and convenience.

Spacious and very quiet, the cab of the JAGUAR minimises stress on the operator. CEBIS helps keep an eye on everything – a real advantage during long working days.

Unstoppable	2
GREEN EYE equipment	4
Front attachments	6
Feeder unit	8
V-CLASSIC chopping cylinder	12
MULTI CROP CRACKER	14
SHREDLAGE®	16
Kernel processing analysis	18
Discharge	20
Silage quality	22
Adapter	26
CLAAS POWER SYSTEMS	28
Drive system	30
Engines	32
DYNAMIC POWER	34
Chassis	36
Cab and comfort	38
Operation	40
Comfort cab	42
Operator assistance systems	46
CRUISE PILOT	46
Steering systems	48
AUTO FILL	50
CLAAS connect	52
CLAAS NUTRIMETER	54
Yield measurement	56
Maintenance and service	58
Maintenance system	60
Hydraulics and electrics	62
PREMIUM LINE	64
Technology in detail	66
CLAAS Service & Parts	68
Advantages	70
Technical data	71

At home in every field.
The CLAAS JAGUAR 800 series.



Configure your JAGUAR 800 GREEN EYE to meet your specific requirements and benefit from savings as you gear up for the next season!
www.claas.com



Discover the exclusive GREEN EYE equipment package, complete with matching design, for the JAGUAR 800 series. Developed for maximum throughput, optimal chop quality, the best in operator comfort and convenience features and high efficiency, the package offers you savings on components that provide you with reliable support in the course of your daily work.

Our exclusive GREEN EYE equipment package



Fully equipped cab

PREMIUM LINE crop flow with shear bar

Optimal crop flow begins with the front attachment.



At work all over the world.

The need for ever higher yields means that the demands placed on forage harvesters are also increasing. Clean crop intake, robust technology and versatility are the all-important factors. With its wide range of front attachments, the JAGUAR is today at work around the world, harvesting a very wide range of crops. The front attachments can be fitted and removed easily, are driven via quick-release couplers and impress with their outstanding ground adaptation.



PICK UP 380 / 300.

- High-performance pick-up reel with five rows of tines for clean grass intake
- Robust roller crop press with large intake auger for high throughput
- ACTIVE CONTOUR for automatic ground adaptation

DIRECT DISC 600 / 500 and 600 P / 500 P.

- Roller crop press for extremely even transfer of crop flow
- MAX CUT mower bed for very clean crop cutting
- Paddle roller for optimal crop flow in short crops
- Very large intake auger for high throughput

ORBIS 750 / 600 / 600 SD / 450.

- Maize front attachments with working widths from 4.5 to 7.5 m
- No need to get down from cab with automatic transport protection for ORBIS 700 / 600 / 600 SD
- Folding process for ORBIS 750 takes just 15 seconds
- AUTO CONTOUR available for automatic ground adaptation and steering

Adapter for ROVIO.

- Fast and convenient connection of combine harvester front attachments, such as maize pickers for harvesting maize cob silage
- Integrated feed roller for even crop flow
- Drive connection to JAGUAR made via quick-release coupler

Straight and fast. The crop flow.

1 Feeder unit.

- Robust with perfect precompression
- Six lengths of cut can be set mechanically
- Slow reversing with hydraulic motor

2 V-CLASSIC chopping cylinder.

- Precise cutting for excellent chop quality
- Chopped material is centred for low wear

3 Corncracker.

- Optimal crop processing
- MULTI CROP CRACKER corncracker

4 Accelerator.

- Central delivery of chopped material for reliable crop transport
- Mechanically adjustable clearance

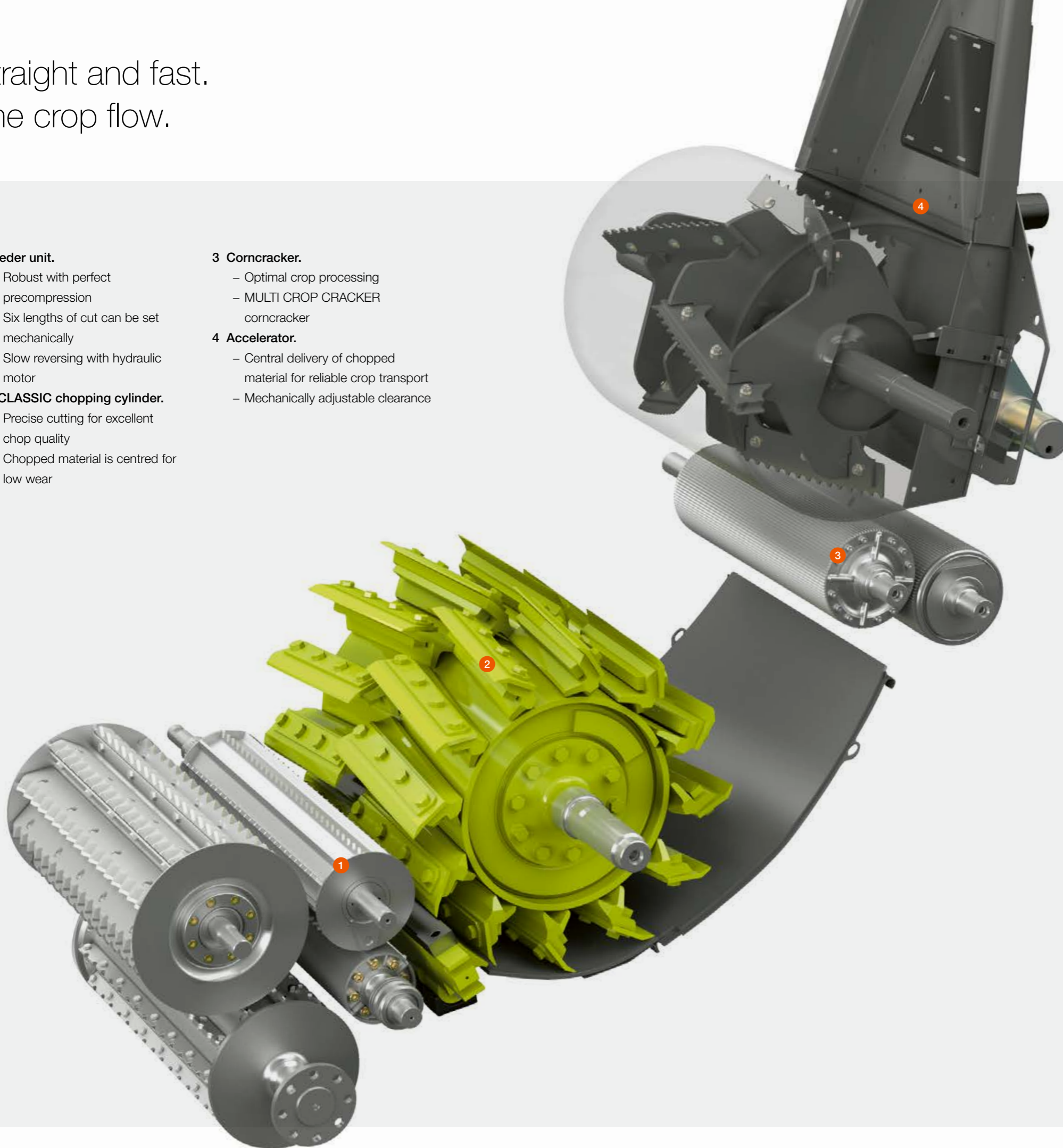

Maximum throughput with low power consumption.

An optimal crop flow is a major factor in achieving a good daily output. The crop flows through the entire machine without any awkward angles. It makes no difference whether the machine is working in grass without a corncracker or in silage maize with one. The crop is accelerated further at each step and is centred increasingly by the V-shaped arrangement of the knives and accelerator paddles. This leads to top performance while keeping the power requirement to a minimum and making for highly reliable operation. The JAGUAR demonstrates this time after time: with outstanding results – measured in terms of the fuel consumption in litres per tonne.



Powerful and reliable. The feeder unit.



Robust rollers.

The feed roller drive in the JAGUAR is designed for extremely high performance. Six lengths of cut can be set as required. Robust compression rollers ensure an optimum crop flow. Additional wear bars reduce wear to the machine.

Hydraulic reverser.

The hydraulic reverser ensures a slow, controlled and sensitive reverse rotation. The crop is gently extracted from the feeder unit. When used with the PICK UP, the roller crop press is raised automatically, and, if required, the auger as well. With incremental reversing, foreign objects are brought close to the feed rollers, where they can be removed quickly and safely.



V 20	
6	8
11	14
18	22

V 24	
4,5	6,5
9	12
15	18

V 28	
4	5,5
7,5	10
13	15,5

In order to meet the requirements of customers in the different markets, the boundaries of the relevant length-of-cut ranges are adjusted accordingly.



Front attachment drive.

The drive power is transmitted mechanically from the chopping cylinder shaft via a four-groove banded V-belt. This provides a reliable drive for front attachments, such as the 6-metre wide DIRECT DISC.



STOP ROCK stone detector.

Although powerful and rugged, the feeder unit is also sensitive when it comes to foreign objects. The STOP ROCK stone detector increases the reliability of the JAGUAR. If it detects a stone in the swath, it stops the feeder unit immediately. You can set the minimum stone size yourself – the sensitivity is conveniently adjustable from the cab using CEBIS.

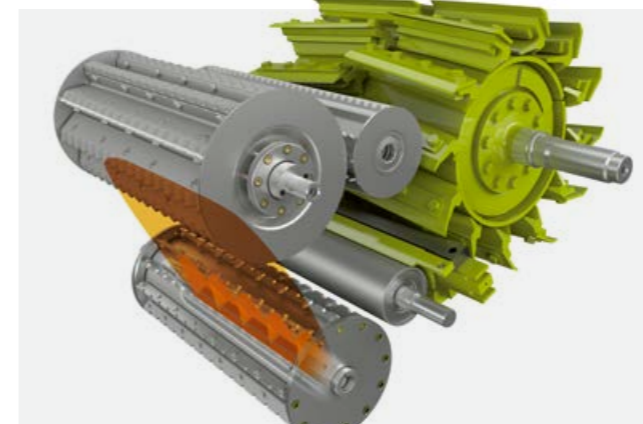

Sensitive metal detector.

The metal detection system installed in the front feed rollers locates any magnetic object in good time. The low-wear, quick-stop mechanism then stops the feeder unit immediately. Thanks to the location display in CEBIS, the operator can quickly see where the magnetic metal object is to be found.

Top performance right from the start.

- Robust feeder unit for perfect crop flow
- Powerful front attachment drive
- Co-ordinated length-of-cut range
- Reliable protection by metal detector and STOP ROCK

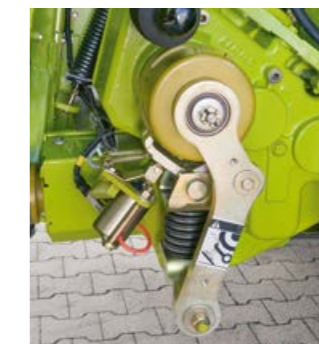

Metal detector power interrupt clutch



STOP ROCK

Precise and proven. The V-CLASSIC chopping cylinder.



V-shaped knife layout.

The 750 mm wide chopping cylinder in the JAGUAR is exceptionally effective. The V-shaped knife arrangement produces a pull-through, guillotine cut with a minimum of effort. At the same time, the forage is guided towards the middle – this reduces wear and friction losses on the sides of the chopping cylinder housing.

- Robust design
- Minimum power requirement
- High throughput
- Top-quality chopped material
- Excellent discharge

V-CLASSIC chopping cylinder available in three versions:

- 1 V20 for use in coarse forage or for use primarily in grass
- 2 V24 for use in grass and maize; suitable for longer lengths of cut in grass
- 3 V28 for use in grass and maize; suitable for short lengths of cut in maize

Fully automatic sharpening.

A precision chop and consistent chop quality are possible only if the blades are absolutely sharp. The sharpening of the knives is controlled from the cab.

Precise cutting.

As an option, you can also control the shear-bar setting from the cab. The shear bar does not need to be loosened for this operation; instead, the mounting block is pivoted and moves gently towards the chopping cylinder with the shear bar firmly fixed on top. Knock sensors register contact and set the shear bar accordingly.

Sharpening and adjustment of the shear bar should be carried out on the basis of the throughput quantity rather than a given length of operation. CEBIS can be configured to give a reminder when knife sharpening is required.

Extending the length-of-cut range.

In order to double the length of cut, the V-CLASSIC chopping cylinder can be equipped with half-section knives. These enable a very consistent crop throughput which is ideal when harvesting grass or maize for long lengths of cut and SHREDLAGE®.

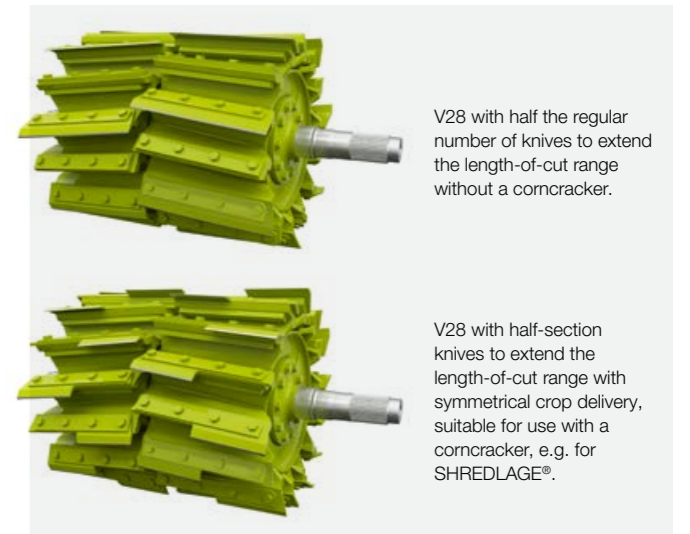

Possible lengths of cut.

Cylinder	Application	Knife set - full	Knife set - half	Half-section knives
V-CLASSIC 28	Knife set	28 = 2 x 14	14 = 2 x 7	28 = 2 x 14
	Length of cut	4 / 5.5 / 7.5 / 10 / 13 / 15.5	8 / 11 / 15 / 20 / 26 / 31 ¹	8 / 11 / 15 / 20 / 26 / 31 ¹
V-CLASSIC 24	Knife set	24 = 2 x 12	12 = 2 x 6	24 = 2 x 12
	Length of cut	4.5 / 6.5 / 9 / 12 / 15 / 18	9 / 13 / 18 / 24 / 30 / 36 ¹	9 / 13 / 18 / 24 / 30 / 36 ¹
V-CLASSIC 20	Knife set	20 = 2 x 10	10 = 2 x 5	20 = 2 x 10
	Length of cut	6 / 8 / 11 / 14 / 18 / 22	12 / 16 / 22 / 28 / 36 ¹ / 44 ¹	12 / 16 / 22 / 28 / 36 ¹ / 44 ¹

¹ Lengths of cut in excess of 30 mm are not approved for use with a corncracker

Specialists deliver top-quality results.

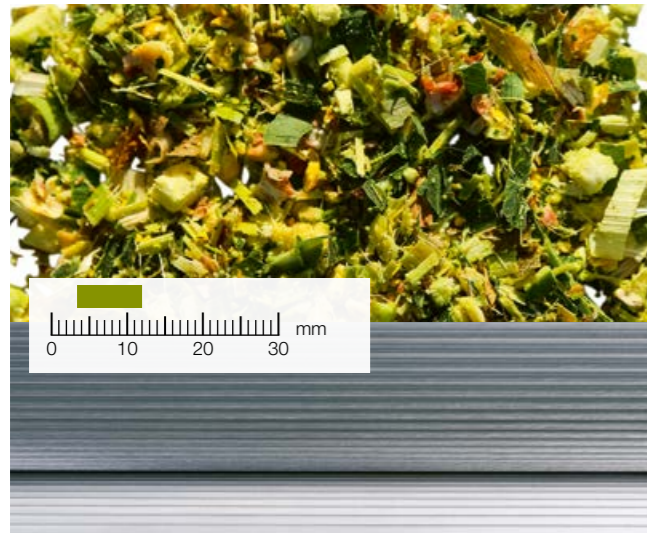

MCC CLASSIC.

The conventional MCC CLASSIC has the proven sawtooth profile and operates with a standard speed difference of 40%. This system can be used successfully when harvesting short maize for biogas plants or producing silage for dairy cattle and finishing beef bulls. The kernel processing score can be increased by adjusting the speed difference.

NEW: For optimal processing of fine-kernel crops such as sorghum, CLAAS offers very fine meshed rollers through CLAAS Service and Parts.



MCC MAX – the power of four.

- 1 Maximum service life through high level of wear protection with Busa®CLAD coating
- 2 Maximum kernel processing
- 3 Maximum possible throughput supported (attained with JAGUAR 880* with engine output up to 653 hp)
- 4 Maximum flexibility to meet different requirements

3,160 hectares of maize in three harvests.

Contractor Meyer from Meppen-Apeldorn will use the MCC MAX for a fourth maize harvest.

*JAGUAR 880 only for selected markets

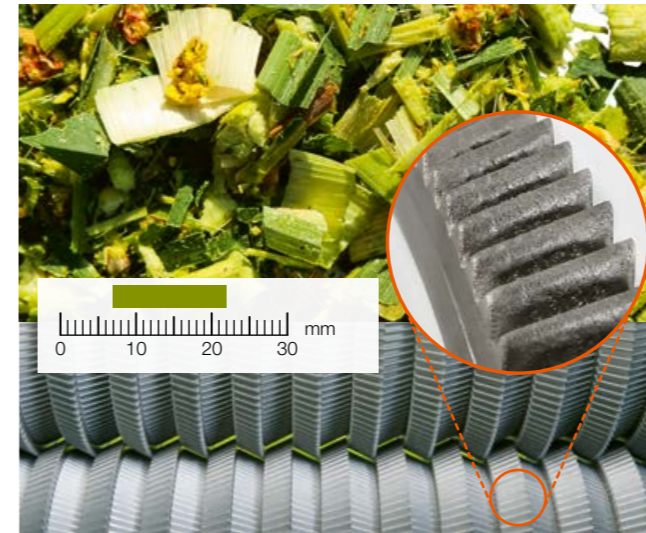

MCC MAX.

The MCC MAX rollers have 30 ring segments with a sawtooth profile. The arrangement and special geometry of the segments ensure that the crop is processed not only by crushing and friction, but also by cutting and shearing forces. This breaks down the maize kernels more intensively and shreds the stalk fragments.

Compared with conventional corn crackers, the MCC MAX has a much wider field of application with regard to lengths of cut and dry matter. At the same time, it delivers processing results of extremely high quality. Its forage processing capability meets the most diverse customer requirements without the need for any change to the machine's equipment.

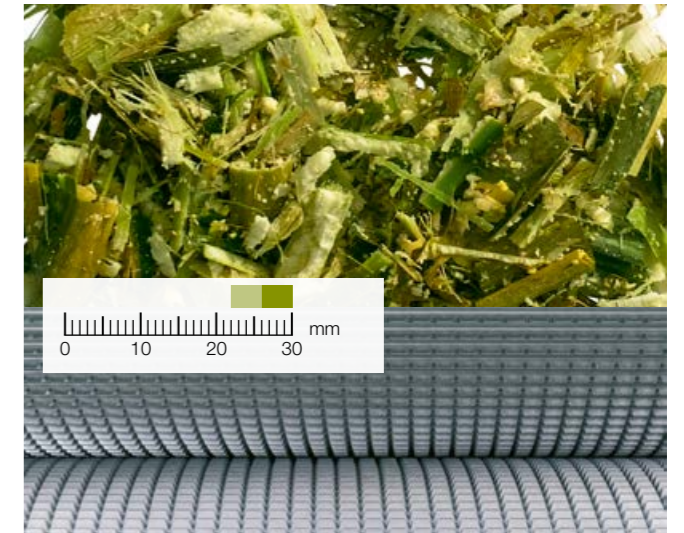

MCC SHREDLAGE®.

Originally developed in the US, this technology is used on many farms around the world in the extremely long length-of-cut range from 26 to 30 mm.

The rollers have a sawtooth profile with an additional counterdirectional spiral groove and operate with a speed difference of 50%. In this way, the MCC SHREDLAGE® is able to grind the maize kernels thoroughly, chop up the cob fragments completely and shred the leaves effectively. In addition to these processing actions, the spiral groove subjects the stalk material to a lateral effect which causes the bark to be rubbed off the stalk. At the same time, the soft inner core is split lengthways. SHREDLAGE® silage can be compressed very well as the material meshes during storage and rebound effects are minimal.

MULTI CROP CRACKER modes of action	MCC M CLASSIC (recommended < 585 hp)	MCC L CLASSIC (recommended > 585 hp)
Number of teeth per roller and diameter for crop take-up and kernel size	80 / 100 with 196 mm Ø for coarse maize	100 / 125 with 250 mm Ø for coarse maize
	100 / 100 with 196 mm Ø for fine maize	125 / 125 with 250 mm Ø for fine maize
	125 / 125 with 196 mm Ø for WCS / MCS	150 / 150 with 250 mm Ø for WCS / MCS
	–	125 / 190 with 250 mm Ø for sorghum (moist)*
	–	190 / 190 with 250 mm Ø for sorghum (dry)*
Roller speed difference for frictional effect	30% ex factory	40% ex factory
Adjustable cracker roller gap	o	o
Engagement of ring segments for cutting effect	–	–
Slanting of ring segment teeth for shear effect	–	–
Counterdirectional spiral groove for peeling effect	–	–

* Only available through CLAAS Service and Parts

o Option – Not available

MULTI CROP CRACKER modes of action	MCC MAX	SHREDLAGE®
Number of teeth per roller and diameter for crop take-up and kernel size	120 / 130 for	95 / 120 for 196 mm Ø
	245 / 265 mm Ø	110 / 145 for 250 mm Ø
	–	–
	–	–
	–	–
Roller speed difference for frictional effect	40% ex factory	50% ex factory
Adjustable cracker roller gap	o	o
Engagement of ring segments for cutting effect	o	–
Slanting of ring segment teeth for shear effect	o	–
Counterdirectional spiral groove for peeling effect	–	o

* Only available through CLAAS Service and Parts

o Option – Not available

SHREDLAGE® for quality milk and meat.



SHREDLAGE® quality begins with the forage harvesting process.

The intensive processing of the crop increases the surface of the chopped material. This results in significantly improved bacterial fermentation during ensiling and, above all, during digestion in the rumen.

Trials conducted by the University of Wisconsin in Madison have shown that SHREDLAGE® drastically increases the physical effectiveness of maize silage while also improving the availability of the starch content. Furthermore, the rumen-friendly structure of the silage promotes herd health.

SHREDLAGE® also for finishing bulls.

The almost complete absence of any examination of the effects of feeding finishing bulls with SHREDLAGE® prompted Osnabrück University of Applied Sciences to conduct the first such feed trial with 72 Fleckvieh bulls.

Feeding with SHREDLAGE® has a positive effect on the carcass yield. Higher conformation results in superior grading and a significantly lower fat score.

Improved livestock health is only one of many advantages which SHREDLAGE® has to offer you. As the availability of starch is optimised, you can reduce the quantity of feed concentrate used. It is also possible to limit or even eliminate the use of fibre supplements such as straw.



The right gap setting cuts costs.

The size of the gap between the rollers determines how intensively the chopped material is processed. The principle to follow here is: only as intensive as necessary. The smaller the gap, the more intensively the crop is processed and the higher the energy requirement of your JAGUAR. This, in turn, means that you will incur higher harvesting costs.

MULTI CROP CRACKER for the best forage.

- For high throughput with optimal processing of the chopped material
- Rugged design through large bearing units and sealed housing
- With maintenance-free belt under constant hydraulic tension for maximum power transmission
- Easily accessible for maintenance or changing rollers

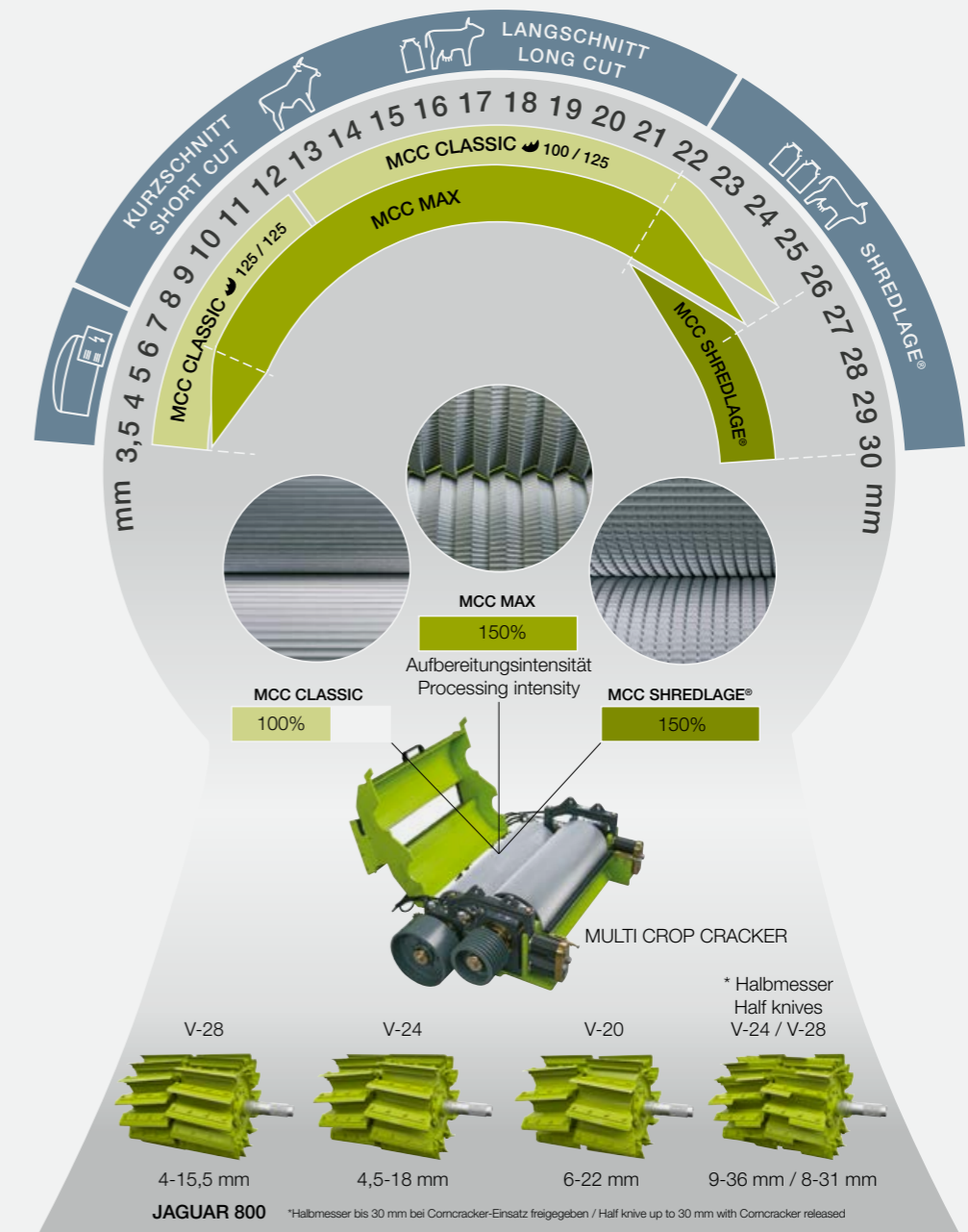

CLAAS connect determines the kernel processing score.



A4 analysis tray



Photographing the spot sample

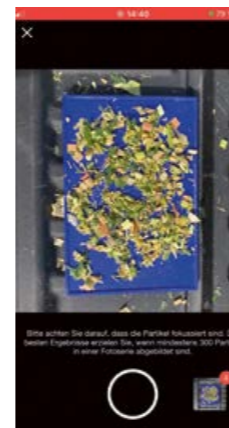

Collecting the spot sample



NEW: The lab in your pocket.

Using the kernel processing analysis app on a smartphone, farmers and contractors can check the quality of kernel processing in the chopped maize silage. This approach provides an easy way of assessing the quality of maize kernel processing while the harvest is still in progress. Lengthy – and by no means highly precise – laboratory analysis is therefore no longer required.

Evaluation of test results shows that the accuracy of on-the-spot CLAAS kernel processing analysis is comparable to that obtained with laboratory tests. The advantage is that the CSPS (corn silage processing score) resulting from the analysis allows you to evaluate the quality of the maize kernel processing on the spot and to optimise the JAGUAR settings if necessary. The values obtained are also documented by the system.

In order to determine the CSPS score, the user starts by taking a one-litre sample, from which at least five to seven smaller individual samples are then extracted. These are photographed with the CLAAS connect smartphone app.

In preparation for being photographed, each sample is placed loosely on an approximately DIN A4-sized blue tray. This intermediate step is necessary to allow the image analysis algorithm to use the contrast and size of the tray to identify and quantify the kernel constituents in the sample.

As soon as all the pictures have been transmitted to the central server, the CSPS score which has been determined is sent back to the user's smartphone in a very short time. In order to calibrate the AI-based analysis software, over 1,000 reference samples have already been analysed in officially approved laboratories. The kernel processing analysis is an AI-based app in CLAAS connect which offers a very fast verdict on the standard of kernel processing in maize.

Fast and reliable crop discharging.

Acceleration – the energy-saving way.

The accelerator is ideally positioned in the JAGUAR. The crop flow does not have to negotiate any awkward angles and is centred by the V-shaped accelerator paddles. This reduces the energy requirement and wear to the side walls.

Discharge capacity can be increased easily.

For heavy crops, you can increase the clearance between the accelerator and the rear wall mechanically by up to 10 mm. This reduces the amount of energy required. If, for example, you are working in very dry grass or starting chopping in a new field and require a high discharge capacity, the clearance can be reduced. This adjustment is made mechanically in the easily accessible maintenance compartment.

For maintenance tasks, such as replacing wear parts, the crop accelerator can be removed quickly and easily. Two experienced engineers require only about an hour for this.

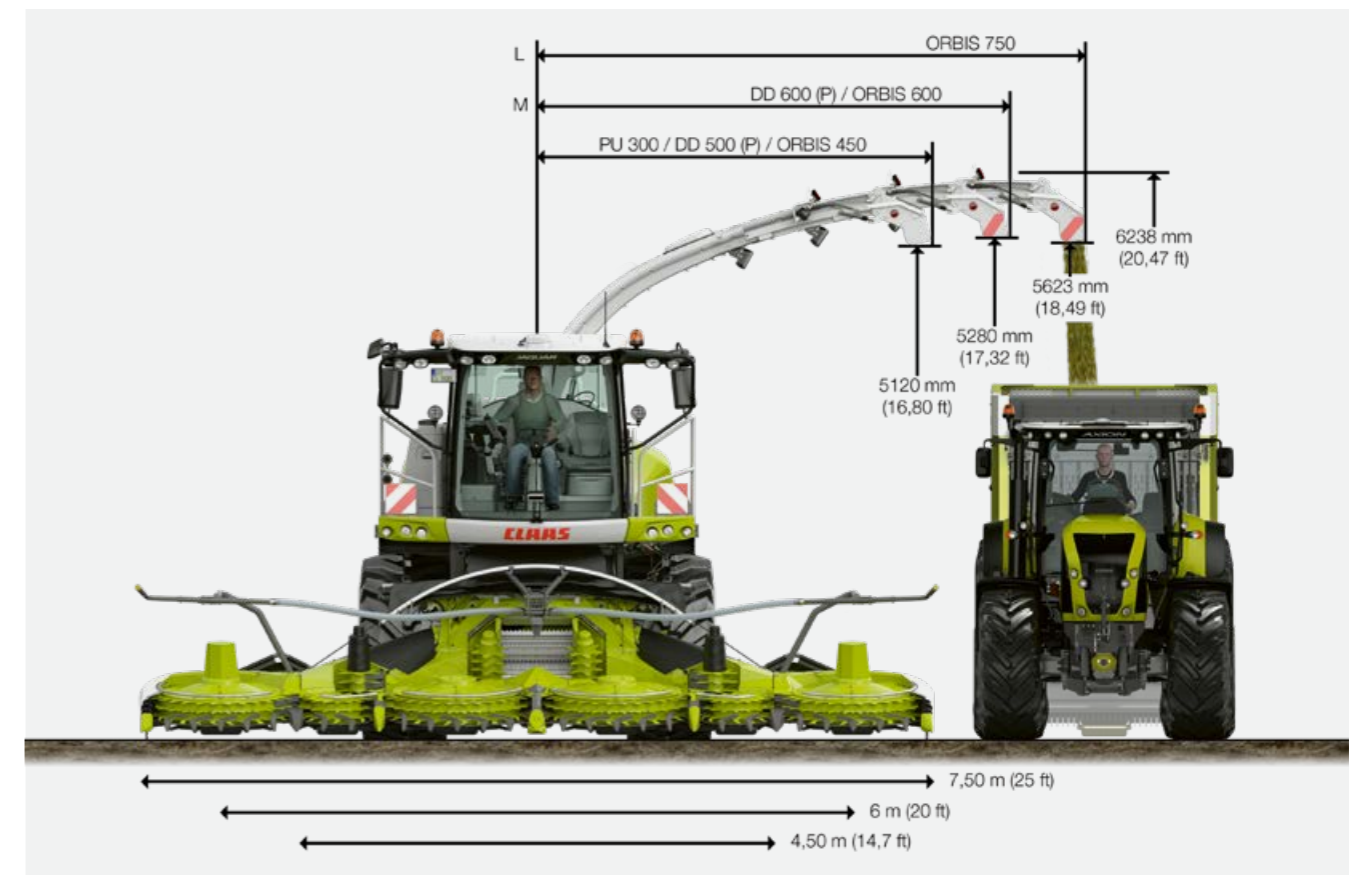
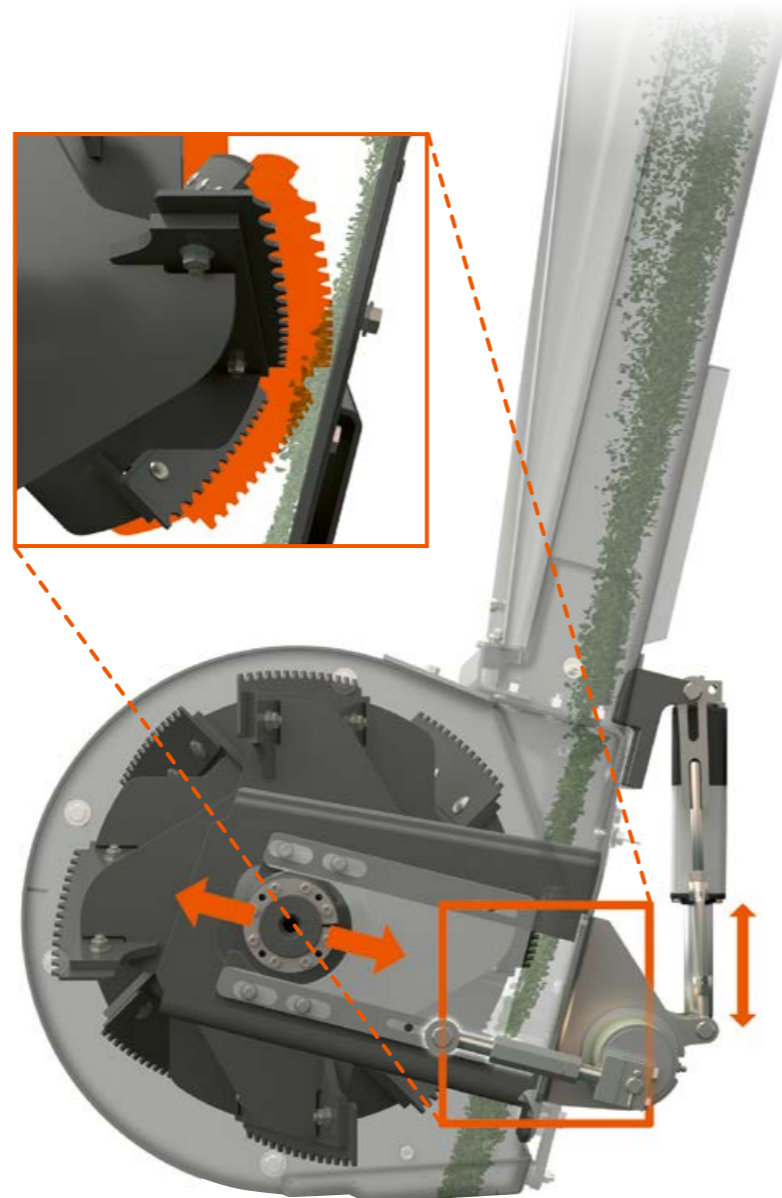

Reliable crop transfer up to a working width of 7.5 m.

High strength and a low dead weight are the key characteristics of the discharge spout. The highly concentrated crop stream can be directed more reliably, minimising wasteful losses. The modular design makes it possible for the system to be adjusted to different working widths.

Two extension modules in sizes M and L allow you to achieve a reliable crop transfer with working widths up to 7.5 m. The entire back of the discharge spout is bolted so that the back plates also function as wear plates.



Easy removal and installation of the accelerator



Mechanical adjustment of the crop accelerator clearance



Robust rotation ring, especially suited to harvesting on slopes or at high speeds

Flexible discharge characteristics.

- You save on the energy required for acceleration.
- You can adjust the discharge capacity mechanically in the easily accessible maintenance compartment.
- The discharge spout has a modular design.
- Working widths up to 7.5 m are possible.

All additives are dosed precisely.

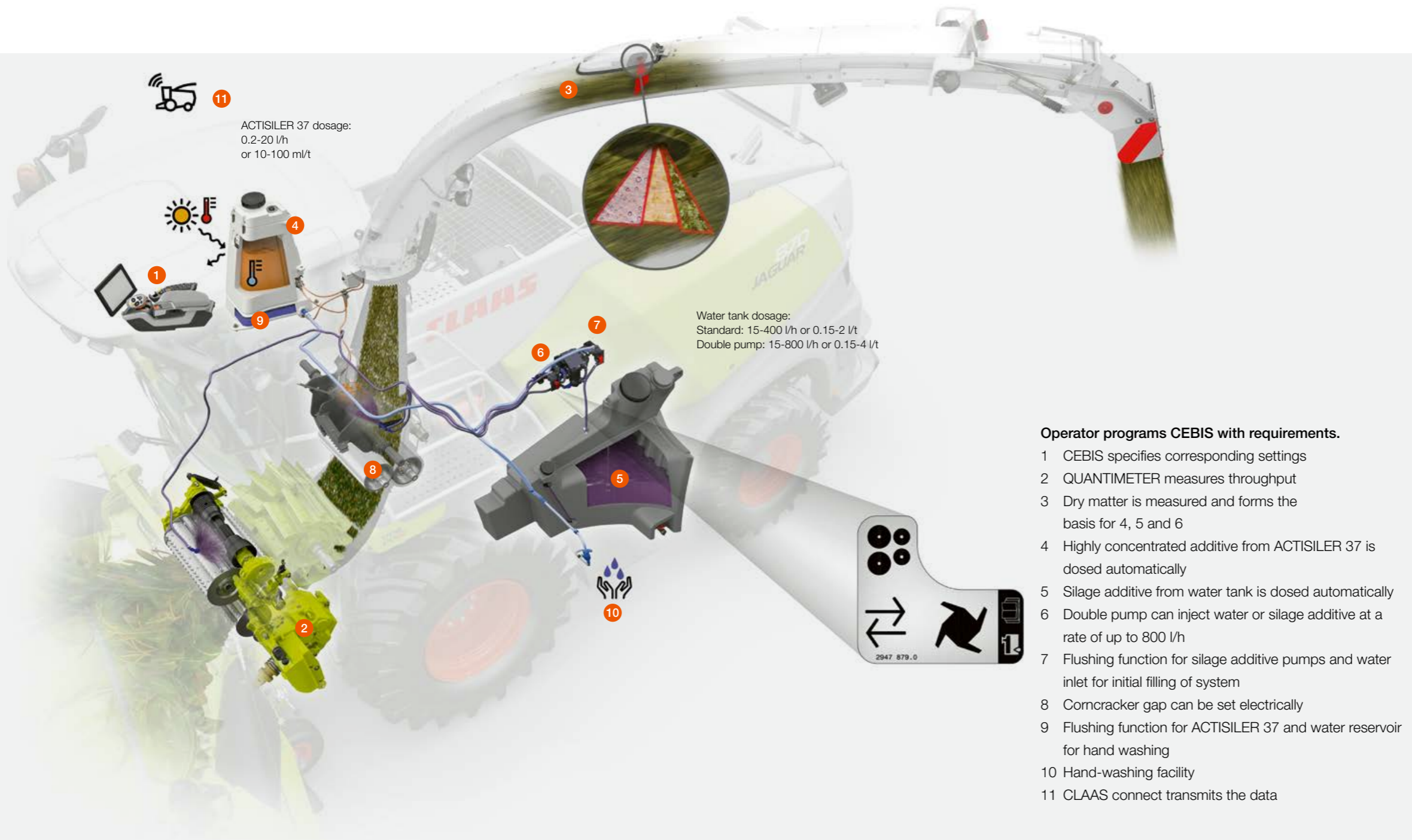

Concentrate from the thermotank.

The double-wall ACTISILER 37 tank protects your silage additive concentrate from high temperatures. For example, if the tank is filled with concentrate at 19°C, it will rise to a maximum of 23°C over a period of ten working hours when the outside temperature is 40°C.



Operator programs CEBIS with requirements.

- 1 CEBIS specifies corresponding settings
- 2 QUANTIMETER measures throughput
- 3 Dry matter is measured and forms the basis for 4, 5 and 6
- 4 Highly concentrated additive from ACTISILER 37 is dosed automatically
- 5 Silage additive from water tank is dosed automatically
- 6 Double pump can inject water or silage additive at a rate of up to 800 l/h
- 7 Flushing function for silage additive pumps and water inlet for initial filling of system
- 8 Corncracker gap can be set electrically
- 9 Flushing function for ACTISILER 37 and water reservoir for hand washing
- 10 Hand-washing facility
- 11 CLAAS connect transmits the data

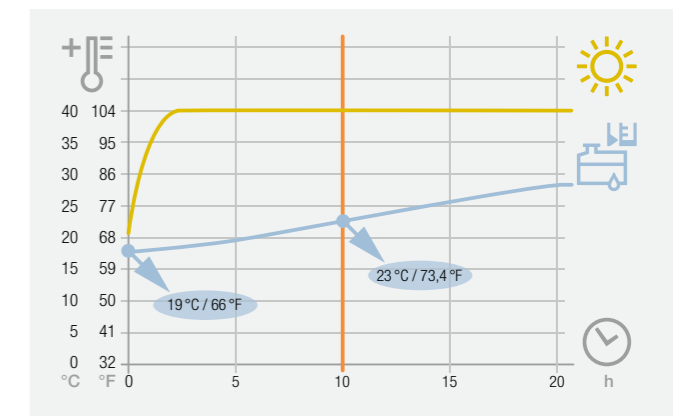

Forage at its finest.

High-quality silage increases the milk yield and stabilises animal health over the long term. The intelligent systems of the JAGUAR form the basis for excellent forage quality: with precisely dosed additives from the 375-litre tank or highly concentrated ones from the new ACTISILER 37.

The dry matter content value determined by the near infrared sensor (NUTRIMETER) serves as a reference for setting the length of cut and the additives.

Dosage via CEBIS.

CEBIS provides the operator with a clear overview of the automatic interplay between the silage additive dosage and the measured dry matter content.

- 1 Dosage applied on basis of current dry matter content
- 2 Programmed dosage from 375 l tank
- 3 Programmed ACTISILER 37 dosage



Optimise your silage quality.



App: helps determine the correct silage additive dosage

Precise dosage with the CLAAS silage additive app.

The app uses the silage additive characteristics, the type of crop and the chosen tank capacity to help you find the correct settings to deliver the required daily dosage. Once you have entered the manufacturer's recommended silage additive instructions and the key data of the JAGUAR, the app calculates the precise dosage for the crop and the harvesting process. The silage additive app is available through CLAAS connect for Android and Apple.

Key data for precise dosage.

- What is the estimated yield (t/ha)?
- What is the size of the area to be harvested (ha)?
- What quantity of silage additive is recommended (g/t)?
- What is the quantity of silage additive in a pack (g)?

Matched to the specific situation.

Once the app has shown you how much silage additive you require, you can determine the dosage. To do this, you need more information:

- Which silage additive system is to be used (ACTISILER or silage water tank)?
- How full is the tank concerned?
- What is the working width (m)?
- What is the estimated working speed (km/h)?
- Is dosing to be performed in l/t or in l/h during chopping?

It only remains for you to enter the calculated dosage in CEBIS. Corrections can be entered at any time while chopping is underway.



Filling the silage additive tank



Entering the app's recommendation in CEBIS

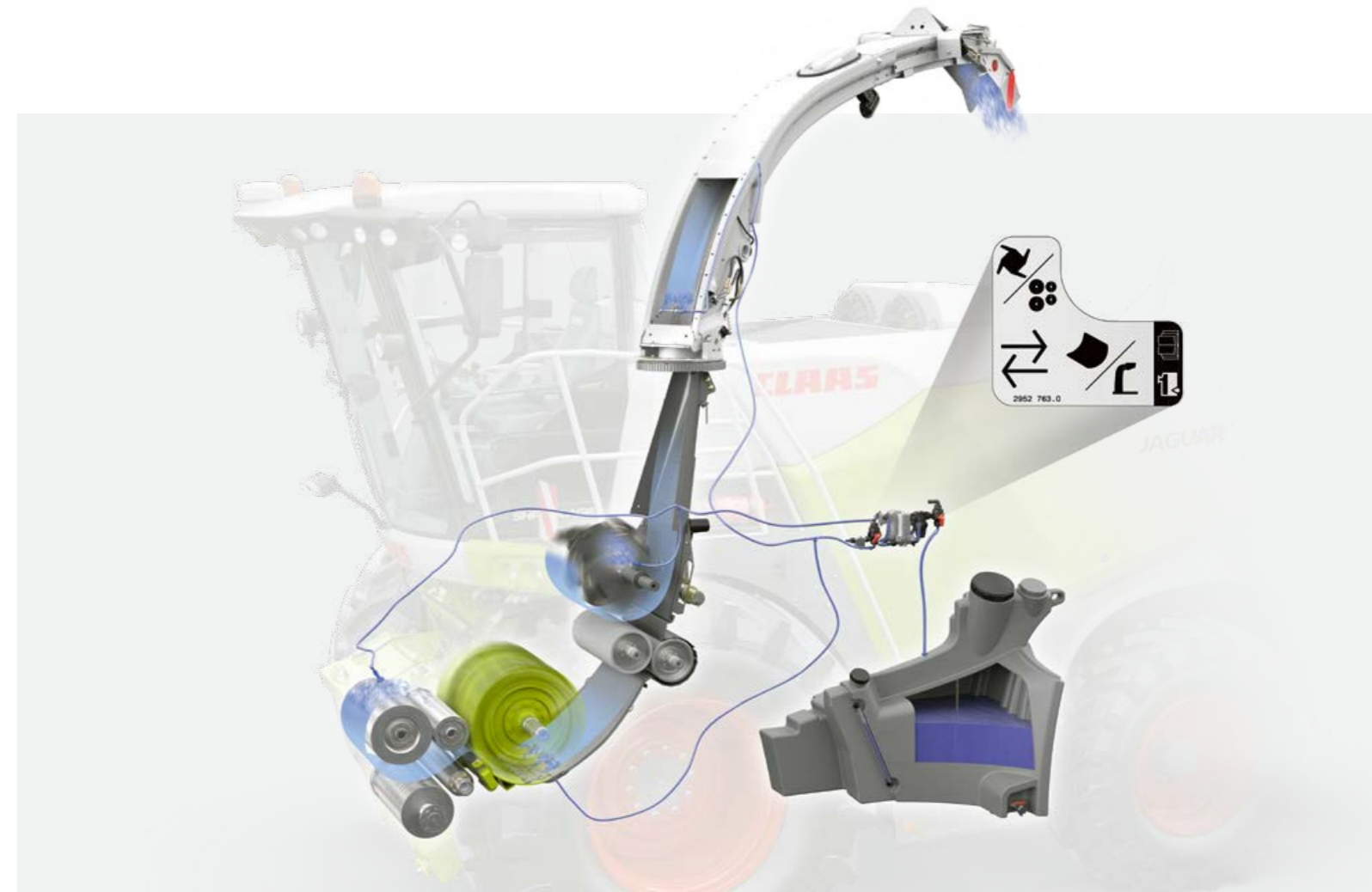

Water to prevent crop flow issues.

If you are harvesting crops with a high sugar content, the programmed injection of water at specific points in the crop flow path — such as the feeder unit, guide plate, accelerator and discharge spout — reduces the build-up of sticky material.

Whenever the crop flow ceases, at the headland, for example, or during forage trailer changeovers, water can be injected automatically. The water from the 375-litre tank moistens the sticky material in the crop flow path. When the crop starts flowing again, the harvested material cleans the crop flow path. It is then possible for silage additive to be injected using the ACTISILER 37 tank.

Silage additive injection up to 800 l/h.

For extremely high silage additive dosage rates, a second silage additive pump can be used to double the dosage rate from 400 l/h to 800 l/h. Control and display of this function are, of course, integrated in CEBIS.



Adapter for maize cob silage (MCS) harvesting.



MCS is forage with a high energy concentration used for milk and meat production.

The new adapter impresses with its perfect crop flow, high throughput and reliable performance.

- Easy adaptation to JAGUAR with power transmission via quick release coupler
- Integrated electrical and hydraulic supply package with multicoupler and central locking
- Integrated lateral compensation for optimal ground contour adaptation by the AUTO CONTOUR system
- Aggressive feeder drum for even and high-throughput crop transfer to the JAGUAR
- Robust design and sturdy transmission for sustained power transfer to the maize picker



Micro-profile rasp bars under the knives for additional crop processing



The wide feed drum with offset paddles adjusts to the material feed height by means of its floating mounting, thereby ensuring that the harvested material is transferred evenly to the JAGUAR.

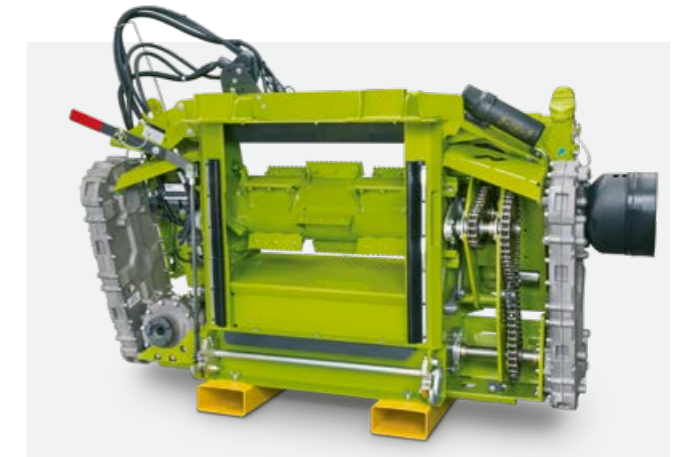

Engagement of the drive is automatic via quick coupler. Power transfer to the maize picker is handled by a robust spur gearbox while the drive to the feed drum is transmitted by a high-performance 80-HD chain drive.



For ideal ground adaptation, the adapter plate is guided hydraulically via the integrated tilting frame with robust rollers. AUTO CONTOUR ensures a uniform stubble height.

CLAAS offers various equipment options for intensive kernel processing.

- Use of an aggressive chopping cylinder concave
- Speed difference increased by 60% when using the MULTI CROP CRACKER CLASSIC
- MULTI CROP CRACKER CLASSIC rollers with 150 or 190 teeth, fine toothing on the roller circumference
- Use of the MULTI CROP CRACKER MAX



Chopping cylinder concave with grating elements for additional crop processing



MCC CLASSIC, 60% speed difference



MCC MAX for particularly intensive processing

The power you need
with the fuel savings you like.



CPS

 | CLAAS
POWER
SYSTEMS

Our driving force: the interplay of select components.

Your CLAAS machine is much more than the sum of its individual parts. Top performance is only possible when all the parts are ideally matched and work together optimally.

In CLAAS POWER SYSTEMS (CPS), we have brought together top-quality components to create an intelligent drive system that sets new standards. Full engine output only when you need it. Drives that are suited to the way your machines are used. Fuel-saving technology which quickly pays off.

Unmatched and efficient. The drive.



Unbeatable for decades.

The revolutionary drive system of the JAGUAR was developed by CLAAS engineers in 1993 and still sets the standard today. The direct power transmission has proven itself thousands of times over in practical use. For this generation of the JAGUAR we have again stayed true to our tradition with a transverse engine arrangement.

Maintenance-free.

The chopper unit is driven directly from the engine main clutch by means of a hydraulically pre-tensioned powerband.

Safe and reliable.

The disc brake attached to the main clutch stops the chopper unit quickly when the main drive is switched off. QUICK STOP enhances safety.

Efficient.

The direct drive transmits power extremely efficiently while also keeping the specific power requirement low.

Convenient.

The front attachment is driven mechanically, with the connection provided by a quick-release coupler.



The JAGUAR main drive.

Tough, reliable and low-maintenance. Five characteristics that deliver top efficiency.

- 1 Transverse-mounted engines
- 2 Direct powerband drive from engine to:
 - Chopper unit
 - Accelerator
- 3 The corncracker is driven directly from the accelerator by a powerband
- 4 QUICK STOP – active braking brings the crop flow to a halt quickly when the main drive is disengaged
- 5 The shaft drive to the front attachment is connected via a quick-release coupler

More throughput. Less energy required.

- Proven and reliable chopper unit
- Efficient and maintenance-free direct drive
- Mechanical front-attachment drive with automatic power transmission via quick release coupler



Quick-release coupler

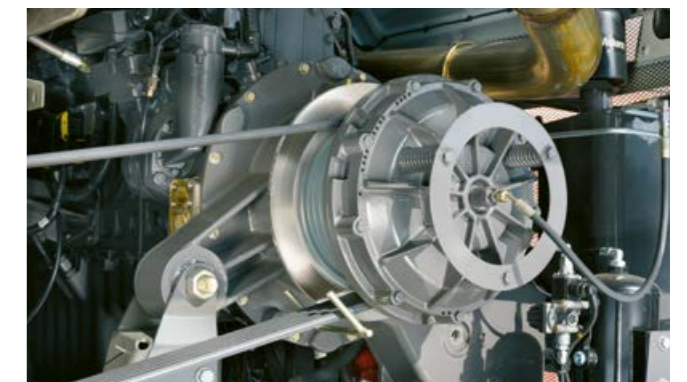

QUICK STOP crop flow brake

Powerful and efficient. The engine technology.

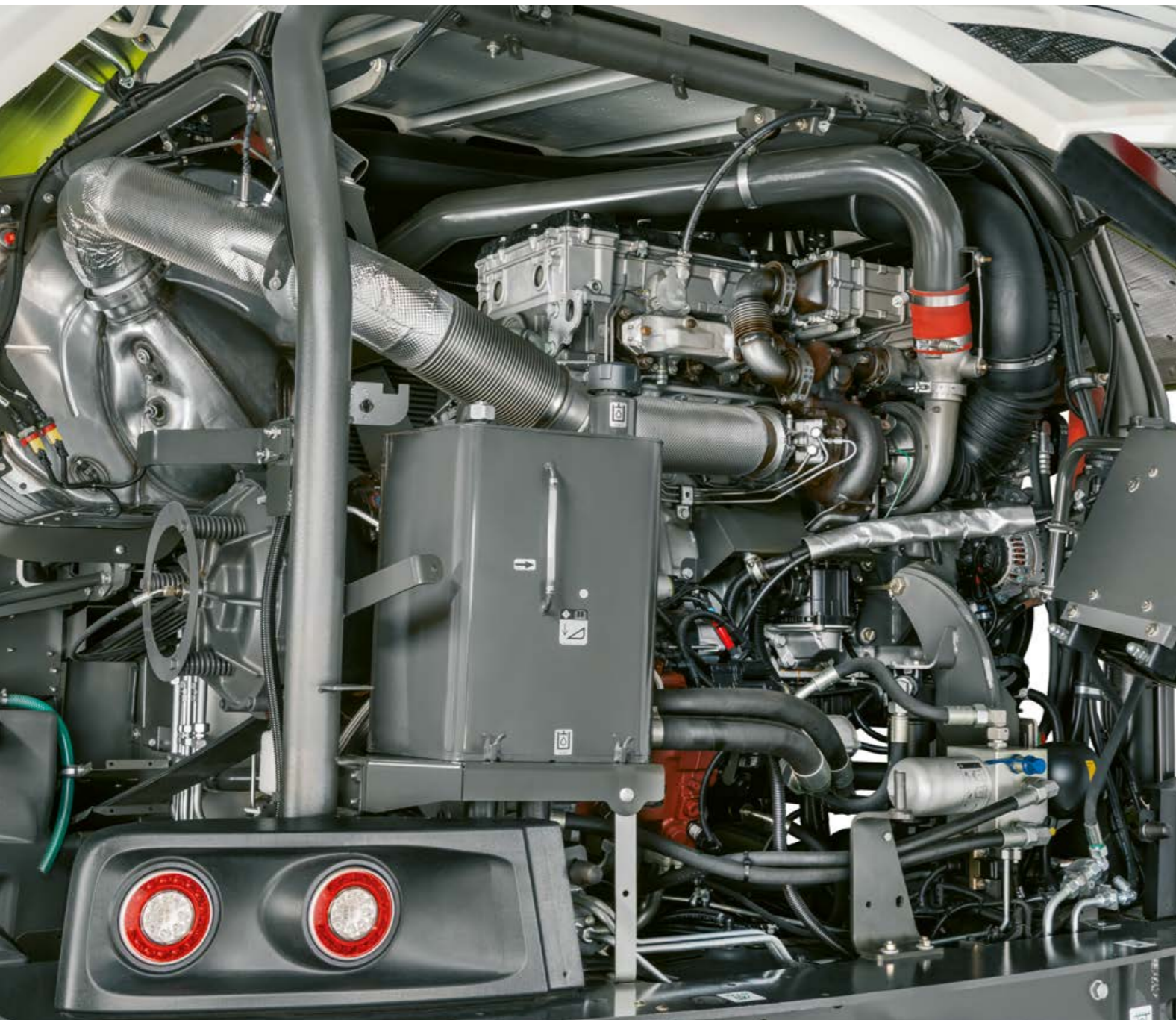

Turbo-compound technology for OM 473 LA



Mercedes-Benz OM 473 LA



Mercedes-Benz OM 471 LA

Power and intelligence from Mercedes-Benz.

All the engines meet the requirements of the Stage V emission standard. The exhaust emissions of the JAGUAR models are cleaned by exhaust gas recirculation as well as by selective catalytic reduction (SCR) in combination with a diesel particulate filter. A 130-litre tank contains the urea solution required for this system.

Latest engine technology.

With displacements of up to 15.6 l, the in-line 6-cylinder engines from Mercedes-Benz deliver impressive performance even under demanding conditions.

- Common rail, high-pressure injection technology with up to 2,500 bar
- Additional turbo-compound technology for maximum efficiency at full load
- Torque is consistent over a wide engine speed range
- Low weight thanks to high power density
- Very low diesel consumption

Large tank for extended working.

The well thought-out tank system is ideal when it comes to planning long working days in the field. A JAGUAR with exhaust gas aftertreatment only requires refilling with urea solution after every second diesel refuelling stop.



Sustainability.

Ex factory, the machine is supplied with its fuel tank filled with HVO fuel (DIN EN 15940). Hydrotreated Vegetable Oil is a synthetic diesel fuel whose pollutant emissions are lower than those of fossil-based diesel as it is free of various pollutants, such as aromatics and sulphur compounds. Characteristics:

- Fuel consumption is unchanged
- HVO and diesel are fully miscible
- Engine noise is reduced by smoother combustion
- CO₂ emissions are reduced



JAGUAR Engines	Type	kW	hp	Displacement litres
880*	OM 473 LA	480	653	15.6
870	OM 473 LA	430	585	15.6
860	OM 471 LA	390	530	12.8
850	OM 471 LA	340	462	12.8
840	OM 471 LA	320	435	12.8

High-capacity fuel tank



JAGUAR	Fuel tank	Auxiliary fuel tank	Total fuel	Urea tank	HVO ready
880*-840	1000 l	300 l	1300 l	130 l	•

*880 only for selected markets

Intelligent and efficient. DYNAMIC POWER.

Only as much power as is required.

The JAGUAR 880*, 870 and 860 models can be equipped with the DYNAMIC POWER automatic engine output control system. Maximum efficiency and throughput are attained when operating at full load. In the partial load range, the engine output is reduced automatically. This makes it possible to attain fuel savings of up to 10.6%.

Maximum output when entering the crop stand.

Before entering the crop, DYNAMIC POWER switches to the maximum engine output setting. If maximum power is no longer required after entering the crop, DYNAMIC POWER reduces the output to the appropriate setting.

Selectable	Step	JAGUAR		
		880*	870	860
Maximum output	10	653	585	530
	9	615	554	504
	8	577	522	478
High output	7	539	491	453
	6	501	460	427
	5	463	429	401
	4	424	397	375
Normal output	3	386	366	349
	2	348	335	324
	1	310	303	298
	min	272	272	272

*880 only for selected markets

DYNAMIC POWER adjusts the engine output optimally to the field conditions in ten steps. This ensures that you are always operating in the most efficient engine speed range.

Reliable cooling.

Horizontal slab radiators provide effective cooling under all harvesting conditions. The large surface area of the radiator screen keeps air speeds down, thereby reducing dirt build-up. The screen is cleaned by a rotating extractor arm. The airflow from the fan flows over the engine and escapes through the large air outlet at the rear. As a result, the JAGUAR is able to take high ambient temperatures in its stride and operate reliably.

Breathing easy.

Large air filters ensure long and reliable operation. Pre-treated engine air is drawn in directly from the radiator compartment. When necessary, the filters can be removed without the need for tools and can be cleaned straight away in the field.



The integrated compressor delivers 600 l per minute at 9.5 bar. This is sufficient to supply the trailer braking system and to allow the operation of air-driven tools, such as an air gun for cleaning the JAGUAR when work is over.



Look forward to lower fuel consumption.

- DYNAMIC POWER delivers fuel savings of up to 10.6% during partial-load operation.
- Cruise control allows you to work consistently and economically.
- The reliable cooling system can be accessed very easily.

Reliable, high tractive power. The chassis.

Huge reserves.

The ground drive impresses with its high tractive power. Harvesting speeds of up to 16.8 km/h are possible in first gear. The low dead weight, the small turning radius and the good ground clearance make for excellent manoeuvrability.

Powerful and manoeuvrable.

- High tractive power
- Small turning radius for high manoeuvrability
- Rear camera for better visibility to the rear
- Flexible rear ballast with wide collision protection element



Mechanical four-wheel drive.

Under difficult working conditions, the selectable four-wheel drive provides maximum traction. The power is transferred directly to the rear axle via a drive shaft. The optional 620/55 R 26 rear tyres with tractor tread provide a correspondingly high level of traction.

Economical on the road.

The electronic ground drive control automatically regulates the engine speed and matches it exactly to the required output. This cuts fuel consumption noticeably and minimises noise levels.

Rear camera: improved view when reversing.

If the JAGUAR is equipped with an optional rear camera, the view from it is shown automatically on the CEBIS monitor when reverse is selected with the control lever. This allows trailers to be coupled safely and improves the operator's view of the surroundings.

Flexible rear ballast.

Ballasting the rear of the JAGUAR is quick and easy. The 850 kg base weight can be fitted with a variety of different weights. The wide, integrated rubber buffer serves as a collision protection element.

There is nothing to distract you.

You will find that you can operate the JAGUAR intuitively in next to no time. The low noise level in the cab and the optimal view of the field allow you to concentrate fully on the task in hand while the steering column and operator's seat can be adjusted to meet your requirements precisely.

Key functions are controlled by means of the CMOTION multifunction lever and a small number of central controls which are laid out logically. All machine functions can be accessed quickly and easily via the CEBIS touchscreen.



Respond faster via the touchscreen.

The JAGUAR can be operated without previous knowledge. This means that even new operators can quickly handle the machine safely and reliably and make use of its performance capacity.

The touchscreen CEBIS gives you fast access to all the machine functions. The most important adjustments can even be made directly by means of switches on the armrest. Precise operation is ensured under all conditions, whether it's a question of a bumpy ride across a field or an operator who is just getting used to the system. You can adjust and operate the JAGUAR in four ways, as required.

A JAGUAR fits the way you work perfectly.

- The clear menu system provides scope for personalised display options.
- Fast access is made easy by the CMOTION control lever.
- The position of the monitor can be adjusted as required for an optimal view.



1 CEBIS touchscreen.

CEBIS responds immediately to a simple tap on the touchscreen. You have direct access to all the machine functions – such as the CRUISE PILOT menu for the basic settings.



2 CMOTION favourites management.

Seven settings can be programmed as favourites and accessed by rocker switches on the CMOTION control lever. You can therefore concentrate on watching the front attachment and crop flow.



3 CEBIS rotary/push switch and pushbuttons.

Even when operating in bumpy terrain, you can easily navigate the CEBIS control panel using rotary/push switches and the Escape and Favourites buttons – e.g. to adjust the shear bar.



4 Direct adjustment via switches.

You operate predefined basic functions directly by means of assigned switches – e.g. to adjust the working width with the section switch.

A cab that's a pleasure to work in.

The clear and intuitive controls make for easier harvesting, even on long working days. The choice of user-friendly entertainment and communication systems makes work seem almost like a hobby.



Hands-free functionality, navigation, playing music – in combination with Apple CarPlay / Android Auto, the sound and entertainment package makes work more enjoyable. The subwoofer gives the sound the right depth and forceful bass delivery.

CLAAS offers preparation for installation of these items as an additional equipment option. It is then simplicity itself for your CLAAS distributor to retrofit the cab with a radio with a 6-inch touchscreen.



Everything you need for easy, high-quality communication and entertainment is provided.

- The DAB+ radio guarantees clear reception of national stations
- The gooseneck microphone ensures that you are heard loud and clear
- No need to plug your phone in to recharge thanks to the inductive charger

- Charging is also possible via the additional USB-C ports
- Large cupholders are on hand for your drinks
- Any sand or dust that gets into the cab can be cleaned out quickly with the integrated compressed-air gun

Clearly laid out, quiet and comfortable.



Your workplace in the JAGUAR.

In the JAGUAR, there is simply nothing to distract you. You have the space you need, are shielded from noise and have a clear view all-round.

- Spacious cab with two seats
- Excellent seating comfort with a choice of comfort seat, leather seat or heated and ventilated premium seat
- LED work lights (characteristics similar to daylight) on cab roof, at the rear and on the discharge spout for optimal monitoring of harvesting operations

Developed for extended working.

- Very quiet and spacious workplace
- Simple, intuitive operation
- Very good view in the field and on the road
- Equipped to a high standard for high comfort



Ergonomic comfort cab.

The steering column and operator's seat can be adjusted to suit each and every operator. Thanks to the clearly laid-out displays and controls, you will feel at home in the JAGUAR in no time.



Wide range of equipment variants.

Roller sunblinds, air conditioning, a radio and a coolbox help to keep you fresh and alert, no matter how long you are on board.



Good communication.

The radio tuning and volume controls as well as those for the telephone (via Bluetooth) are integrated in the armrest.



Lighting as bright as day.

LED work lights on the cab roof and at the rear turn night into day for you. The LED spotlight on the discharge spout pivots with the crop flow.

LED road lights are available as an option.

Automatic and adaptable. CRUISE PILOT for maximum efficiency.

Make life easier for your operators.

Although they vary depending on the individual farm and task concerned, the demands made on operators can be very high and are constantly increasing. CLAAS operator assistance systems have been developed to make your operators safer and more proficient, to make your harvesting run more smoothly and to reduce your costs. As a result, you are able to make more efficient use of the JAGUAR throughout the whole working day.



Making optimal use of engine capacity.

The automatic control of the ground speed by CRUISE PILOT allows the engine load to be used to the full. The operator specifies the desired engine load in CEBIS by setting the corresponding engine speed. CRUISE PILOT is activated easily by means of the multifunction control lever. The JAGUAR now seeks to operate at the set engine load all the time. If the crop suddenly becomes more dense, the ground speed is reduced automatically. If the crop density diminishes again, the ground speed of the JAGUAR increases until the preset engine output is attained. This automatic adjustment is based on the detection of the throughput and the engine load.

CRUISE PILOT is an operator assistance system.

You choose the appropriate strategy:

- Cruise control
- Constant throughput
- Engine load

Using the basic setting mode in CEBIS, accessed through the settings menu or via the machine silhouette, you can adjust the selected mode in accordance with the operating conditions while the machine is running.

- Greatly eases the operator's workload
- JAGUAR performs at maximum efficiency

Maximise use of engine capacity. Minimise strain on the operator.

- Easy activation of CRUISE PILOT by means of the multifunction control lever
- Constant throughput through automatic adjustment of ground speed
- Operator's workload is reduced considerably

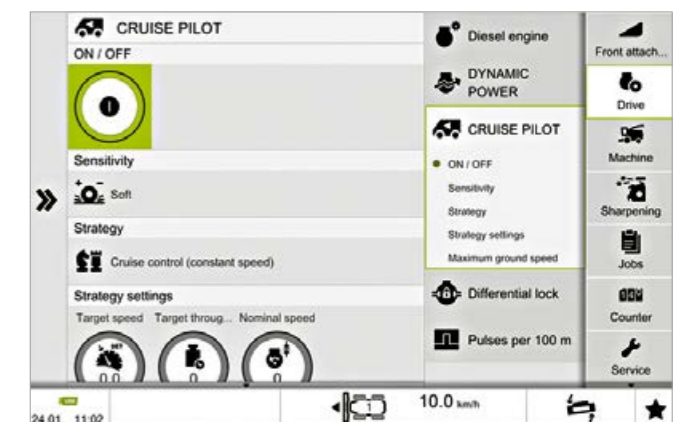

Three assistants for outstanding harvesting precision.

Easy steering.

Precise steering is decisive for the efficiency of your entire harvest operation. Automatic steering systems, such as AUTO PILOT, CAM PILOT and the satellite-based GPS PILOT CEMIS 1200 can greatly reduce the burden on your operators.



Sensor-based with AUTO PILOT.

Row-independent maize front attachments also usually follow maize in rows, a task in which they are assisted by the AUTO PILOT. Two sensor arms each scan a row of maize. The signals they generate are translated into corrective steering impulses. Twin-row sensing allows automatic steering in row widths from 37.5 cm up to 80 cm.



Vision-based with CAM PILOT.

The CAM PILOT assumes control of steering the JAGUAR in combination with the PICK UP. The swath is detected as a three-dimensional image by a twin-lens camera. Corresponding signals are transmitted to the steering mechanism in the event of deviations in the swath shape or direction. The steering axle then responds to these steering commands. This makes for reduced operator workload at speeds up to 15 km/h.



CEMIS 1200 terminal with intuitive control.

You can count on the support of the CEMIS 1200 terminal for precision GPS tracking and job management.

- Bright 12-inch display
- Fast touchscreen operation
- Freely configurable working areas

Online job management between office and machine.

With CEMIS 1200 and an active Machine connect licence, you can handle your job management via your mobile phone connection in just a few clicks. Plan jobs, including reference tracks, in CLAAS connect and transfer them straight to the machine. On completion, the operator uses the same quick and easy method to send the job data, including the yield data, back to the office.

- Assign, complete, document – easily and reliably.

Satellite-based with GPS PILOT.

Using satellite signals, the GPS PILOT guides the JAGUAR reliably and with unsurpassed precision in parallel lines, along curved contours defined by the crop edge or along reference tracks which have been defined by the operator. It is possible for the operator to make use of the full working width and to reduce overlaps to a significant degree. The system works at night or in low visibility just as precisely as it does in full daylight. Existing GPS track lines in ISO XML format – produced by a swather during grass harvesting or generated during maize sowing, for example – can be used with the GPS steering system of the JAGUAR.

Antenna and receiver are housed together in the roof unit. The SAT-900 GNSS receiver is provided with SATCOR 15 by Trimble RTX as standard.

- 5-year licence for use of SATCOR 15 by Trimble RTX
- Pass-to-pass accuracy +/- 15 cm
- Pass-to-pass accuracy as high as 2 cm is available as an option



SAT-900 antenna and receiver in one unit – with anti-theft protection

Only an automatic system can fill a trailer as reliably as this.

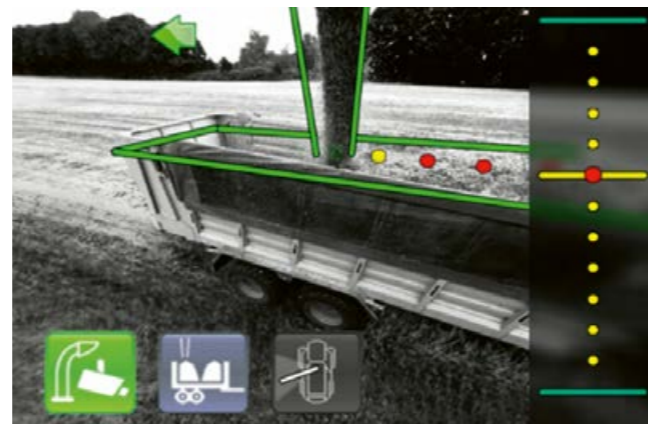

AUTO FILL for automatic trailer filling.

AUTO FILL is based on digital 3D image analysis. The system takes care of controlling the position of the discharge spout to the side or the rear. In chopping start-up mode, you choose the direction in which discharging is to take place. For automatic filling to the rear, only the desired impact point needs to be specified. In crosswinds or on steep slopes, the impact point can be corrected. You can always see the target impact point indicated on the AUTO FILL camera image.

OPTI FILL for maximum operating convenience.

The optimised spout control system makes it easy to manage the discharge process, even without AUTO FILL. A large swivel angle of up to 225° ensures that you have an optimal view of the process. When the discharge spout is swivelled, the end flap is adjusted automatically in such a way that the discharge takes place parallel to the direction of travel.



Two permanently programmed spout positions simplify the swivelling process at the end of the field. The discharge spout can also be returned to its parking position automatically at the touch of a button.

NEW: Indication of impact point for side discharging.

When the machine is discharging to the side, the operator is given a virtual indication of the impact point of the harvested material. In automatic mode, the discharge stream can target the impact point for efficient trailer filling.



NEW: Trailer changeover while on the move.

An exclusive function allows the operator to change to a different discharge trailer while AUTO FILL is running. This function is triggered by double-clicking the AUTO FILL button. The end flap opens at a preset angle so that the crop stream is directed accurately to the empty trailer running alongside. While this is happening, AUTO FILL is in standby mode and is reactivated by the operator as soon as the fully laden trailer is no longer picked up by the camera.



Rear discharging.

If there is a changeover from side discharging to rear discharging, as a result of a change of chopping mode, for example, the operator only has to define the impact point by actuating the discharge spout flap.



Avoid operator stress and losses.

- Automatic filling of transport trailers to the side and rear reduces the operator's workload
- Video display with symbols - indicating the position of the discharge spout, for example
- Accurate guidance of crop stream when changing trailer

CLAAS connect links the JAGUAR with your farm.

With the CLAAS connect app, you are able to benefit from all the advantages of modern farm and fleet management, make greater use of the performance capacity of your machines and reduce your workload at the same time. The app combines digital machine management with documentation, application mapping and yield mapping on a secure, cloud-based platform.

Once installed, the system guides you through the entire farming year and helps boost profitability while supporting your decision making, from sowing to harvesting.



High operational reliability.
You are directly connected to Service support and can order parts and consumables through Parts Doc and Lubricant Advisor.



Automatic documentation.
All yield and NUTRIMETER data are processed precisely.

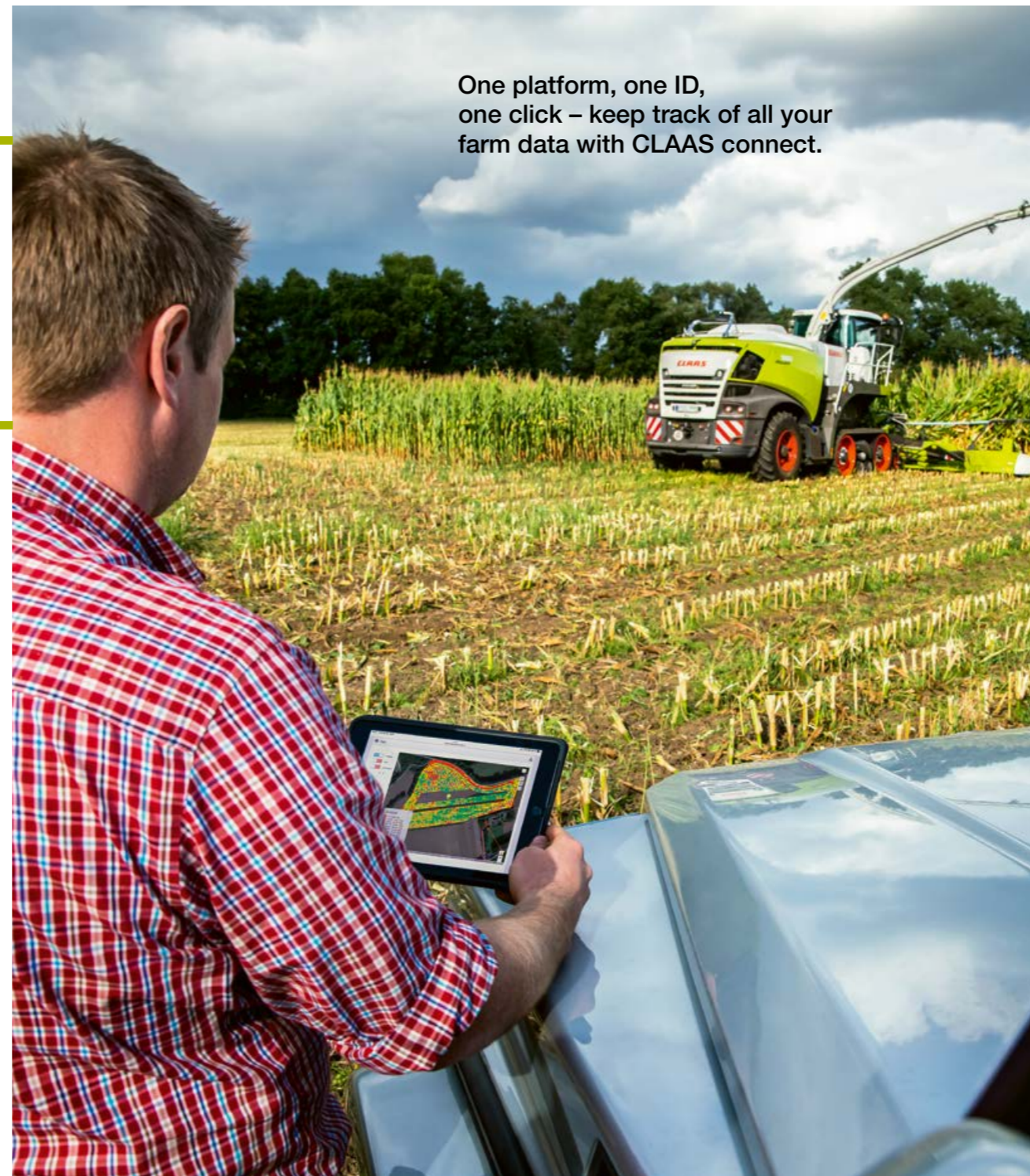

One platform, one ID, one click – keep track of all your farm data with CLAAS connect.



Clear geodata.
You can manage your yield maps and other geodata in a structured way in one place.

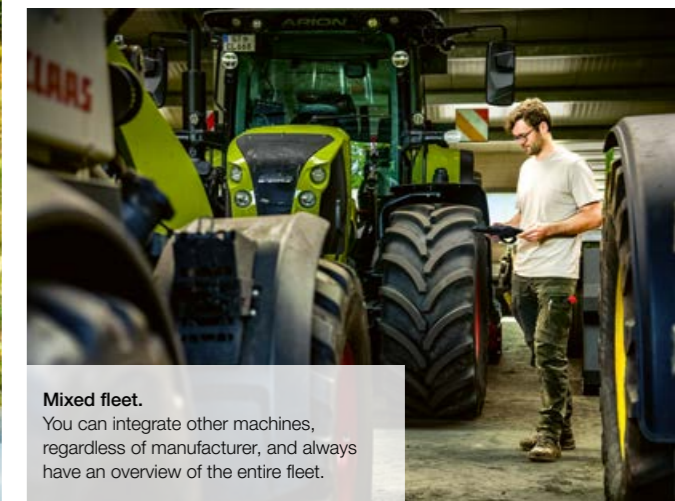

Mixed fleet.
You can integrate other machines, regardless of manufacturer, and always have an overview of the entire fleet.

Full performance from your machines.
You can compare machine settings, analyse operating times precisely and calculate the estimated time until completion of the job.



CLAAS connect gives you a global view of your machines and allows you to monitor the progress of work in the field so that you can plan how to use your fleet effectively.

Your work, including yield and NUTRIMETER data, is documented automatically. You can easily plan track lines in the office beforehand and transmit them straight to your machines.



CLAAS connect package

Documentation

- CLAAS connect
- Machine connect



CLAAS connect package – Professional

Documentation + Steering system + Precision farming

- CLAAS connect
- Machine connect
- GPS PILOT CEMIS 1200



CLAAS connect package – Professional with NUTRIMETER

Documentation + Steering system + Precision farming

- CLAAS connect
- Machine connect
- GPS PILOT CEMIS 1200
- NUTRIMETER:
 - Maize constituent measurement
 - Automatic length-of-cut adjustment



In order to benefit from the full functionality of CLAAS connect Farm Management, one CLAAS connect farm licence is required per farm. Please note: list price offers can be found in the configurator.

The JAGUAR determines the forage quality while out in the field.

The CLAAS NUTRIMETER is a near infrared sensor that measures the dry matter in your harvested material. It is also able to provide data about the constituents – such as starch, crude protein, crude fibre, crude ash, crude fat and sugar – of various crops. All this happens in real time, providing you with precise data about the quality of the forage while harvesting is still in progress.

The results are displayed directly on the machine in CEMIS 1200 and are transmitted to your office CLAAS connect account to provide you with precise documentation.



With the CLAAS NUTRIMETER you have a reliable near infrared sensor which you can also use on the spot in the field.

Sensor-based values (constituents)	Grass	WCS	Maize
Dry matter	●	●	●
Moisture	●	●	●
Starch	–	●	●
Crude protein	●	●	●
Crude fibre	●	●	●
Crude ash	●	●	●
Crude fat	●	●	●
Sugar	●	–	–

● Standard – Not available

CLAAS NUTRIMETER. When you want to know exactly what you're dealing with.

Automated processes



Higher silage quality



Precise documentation



Practical benefits



Accurate silage additive dosage based on throughput or dry matter content

Automatic length-of-cut control in accordance with dry matter content

Dry matter content monitoring for grass, WCS and maize on the spot in the field

Accurate documentation and precise transmission of harvest data

Identification of constituents: starch, crude protein, crude fibre, crude ash, crude fat and sugar



Fermentation process and aerobic stability are improved

Enables uniform compaction and processing

Harvesting point is determined on basis of crop maturity

Direct information for quality control of the silage while it is stored in the clamp

Indispensable knowledge for optimum feed ration composition

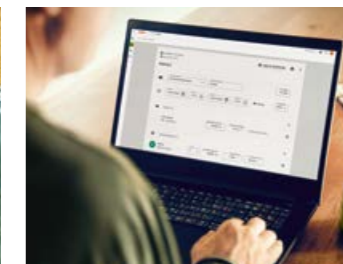

Quantity of silage additive dosed is documented

Machine settings available online

All harvest data available in precise form

The dry matter content is an important parameter, e.g. for crop sales and feed

Data as basis e.g. for selection of crop variety for next harvest



Silage additive costs of 2-5 € per tonne of fresh mass make precise, strategic dosing a necessity

For example: automatic adjustment of the length of cut from 30 mm (at 30% DM) to 26 mm (at 35% DM) for optimally processed SHREDLAGE® silage

A crop which is not in the optimum dry matter range leads to silage effluent formation, starch loss and deficient fermentation

For precise and therefore fair billing on the basis of dry matter content

Guarantees better forage

Precise yield registering with measurement of throughput and constituents.

Practical data management is essential.

Data have long since become an indispensable resource. To profit from their full potential, you should always keep a close eye on the results and know how you can make use of them effectively.

Online registering of the crop yield, moisture content and constituents by means of the QUANTIMETER and NUTRIMETER plays an important role in documenting your machine activity. In order to achieve this, you should ensure that all the systems, machines and work processes are connected in such a way as to provide useful results. The data generated are sent to many different places for analysis.



QUANTIMETER.

Determining the throughput.

The deflection of the precompression rollers is registered and the volume flow measured continuously. Corresponding calibration by counterweighing allows you to achieve a very high degree of accuracy in measuring the throughput. The calibration status is displayed to the operator in CEBIS.



Advantages for you:

- Transparent harvest data for every machine deployment
- No overloading of forage trailers
- Precise data as basis for source stream accounting and fertiliser ordinance



NUTRIMETER.

Determining the dry matter.

The measuring procedure using near infrared spectroscopy runs continuously during the harvesting process. A light source in the upper discharge spout is directed at the crop as it flows past. The light is reflected back in different ways, depending on the crop moisture level.

As well as providing data on dry matter content, the NUTRIMETER supplies information about the constituents of different crops. The figure for crude ash content, for example, can be used as an indicator for setting the LINER rake height.



Advantages for you:

- Basis for invoicing by dry matter content
- Automatic silage additive dosage and length-of-cut adjustment possible on basis of dry matter content
- Forage quality is already registered during harvesting

Advantages for you:

- Reliable indicator of forage quality
- Quality of different varieties supports decision-making during cropping planning, e.g. on basis of starch content

People and machines
you can count on.



Keep downtime to a minimum.

Operating the JAGUAR, you benefit from extremely wear-resistant components which make your machine even more reliable. And from a well thought-out maintenance system that saves a lot of time. From practical details, like the standard compressed-air system which makes cleaning the machine easy. And from the dedicated mechanics of the CLAAS service team, who are there for you 24 hours a day.

Quick and straightforward. Unique maintenance system.



V-opening action



Air filter change without tools

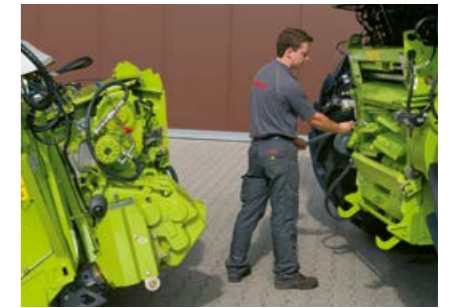

Ease of access to chopping cylinder

Extremely maintenance-friendly design.

- Once the housing has been opened hydraulically, you have a perfect view of the knives and shear bar.
- It takes just ten minutes to separate the chopping cylinder and the feeder unit on the JAGUAR.
- The automatic central lubrication unit with storage for eight litres of grease is sufficient for around 120 hours of operation.
- Large side panels allow unrestricted access to the engine, the cooling system, the corncracker and the accelerator.
- If maintenance is required, the accelerator can also be removed by two people in the space of an hour.
- The on-board compressed air supply can be used for many different cleaning tasks.
- The maintenance lighting makes it possible to carry out maintenance work during the hours of darkness, too.
- A high-specification tool kit makes it easy to perform maintenance tasks.

Reliable Remote Service.

CLAAS Remote Service is ideal for fast problem resolution and proactive maintenance planning. On identifying a fault, the machine informs the operator and automatically sends an error message to the service partner. The service partner has access to all the relevant data, identifies the fault remotely and is able to prepare for the intervention to rectify it.

Remote Service makes periodic maintenance tasks much easier to schedule. The machine informs the CLAAS service partner of the upcoming maintenance requirement. The service partner suggests an appointment time for the maintenance to be performed and, depending on the scope of the maintenance, places an advance order for CLAAS ORIGINAL consumables.

High operational reliability.

Every minute counts in the short forage harvesting period. Time-consuming maintenance work is a nuisance and also a cost factor, since it reduces the number of productive hours – and also your profit margin. The automatic central lubrication system and combined grinding and shear-bar adjustment function are just two examples of how maintenance times can be reduced and operating times boosted.

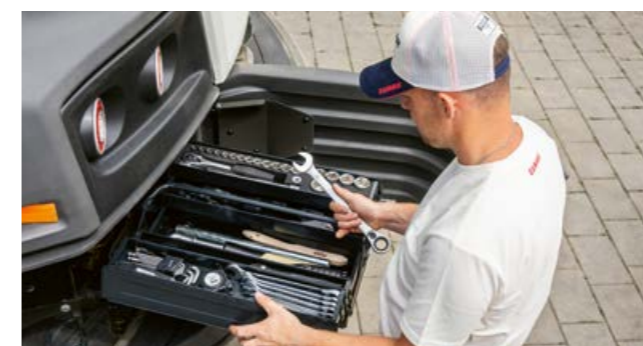
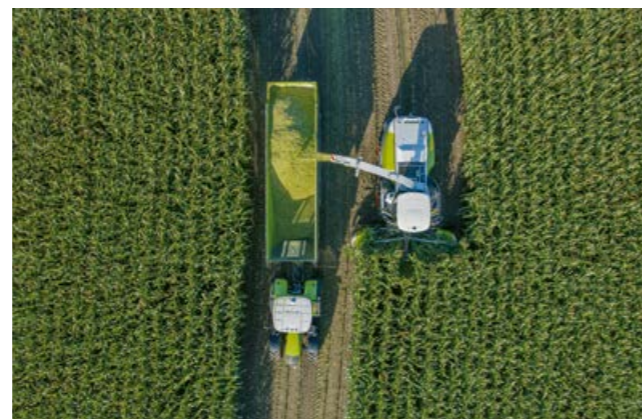

Clear and straightforward. Hydraulic and electrical systems.

Clear hydraulics control.

The spool valves are clearly laid out on the left side of the machine. Proportional valves for the discharge spout and front attachment control system allow a smoother response when these systems are functioning automatically. In order to enable a consistent stubble profile, even when operating at very high ground speeds, the actuation speed of the ORBIS lateral levelling mechanism, for example, can be adjusted as required in CEBIS.

Active oscillation damping.

The active oscillation damping function suppresses movements of the front attachment extremely effectively, thereby making your progress from one job to the next much smoother. Oscillation damping is activated automatically – when turning at the headland with the front attachment raised (above working height) for example.

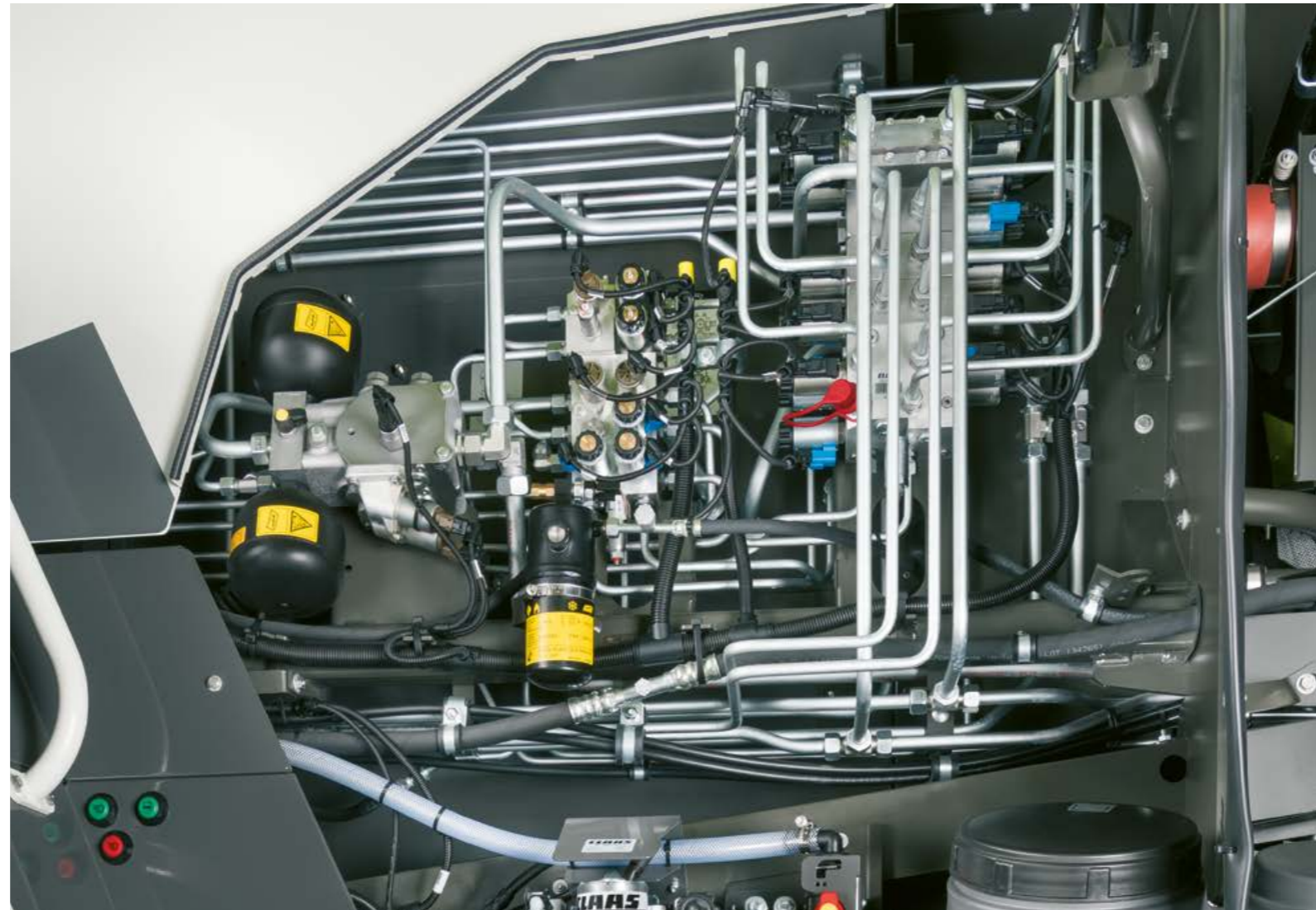

Easy-maintenance electrics.

A straightforward, convenient control concept demands a fast, reliable electrical system. In the JAGUAR, all the key components are housed securely and centrally in the cab.

An expansion box in the maintenance compartment of the JAGUAR allows the easy accommodation of additional options when retrofitting:

- PROFI CAM
- OPTI FILL / AUTO FILL
- ACTISILER 37
- NUTRIMETER
- Auxiliary fuel tank

Well thought-out solutions.

Robust implementation.

- Hydraulic system with proportional valves for gentle actuation of discharge spout and front attachments
- Active oscillation damping for safe running in the field and on the road
- Electrical system housed centrally in the cab
- High-quality cable connections
- Extension box for straightforward adaptation of up to five retrofit solutions

Sometimes you just have to get tough.

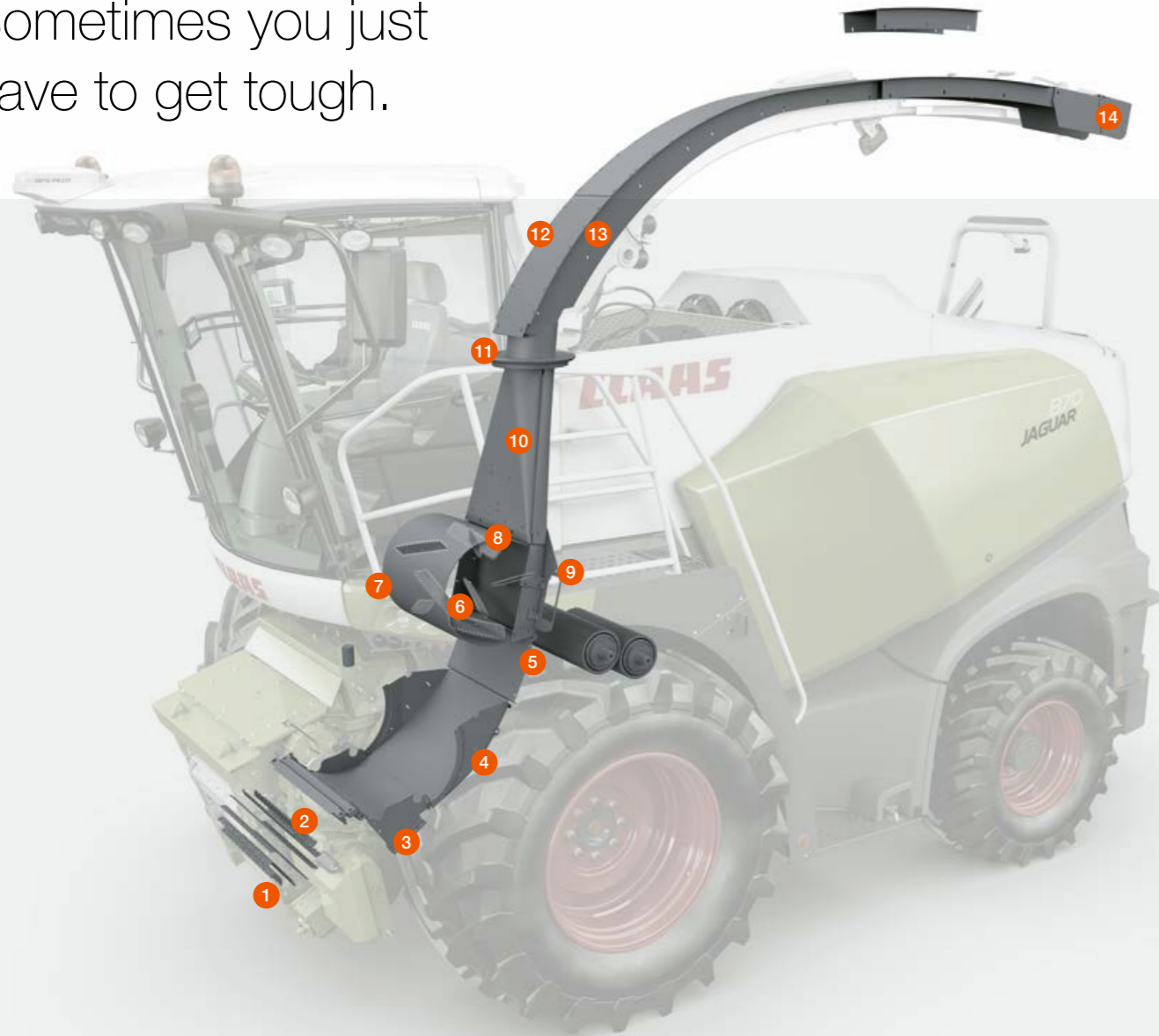

Greater operational reliability with PREMIUM LINE wear protection.

Guaranteed performance level.

Even under the most demanding harvest conditions, CLAAS PREMIUM LINE parts provide very high wear resistance and a long service life. This increased durability is made possible by special manufacturing processes, high-quality materials and special coatings.

PREMIUM LINE for ORBIS.

Highly wear-resistant parts are recommended for extreme operating conditions – where there is a high proportion of sand, for example, or extended periods of operation. A tungsten carbide coating ensures that the knives have a long service life. The speed difference between the cutting disc and the transport disc creates a self-sharpening effect.

The objective of the PREMIUM LINE system is for the service life of the parts to be at least twice or three times that of standard parts. Practical experience shows that this objective is indeed attained. This is why we guarantee* a specified performance level for factory-fitted PREMIUM LINE parts on the basis of hours of use or machine age.

The easily accessible cutting discs and transport discs have a modular structure comprising six segments. As a result, in the event of damage, you only need to replace the segment concerned, rather than the entire unit.

- 1 A special wear coating gives intake drums low wear characteristics
- 2 Interior guide strips made of steel (standard equipment)
- 3 Exterior guide strips made of steel
- 4 Wear elements to protect the large cutting discs
- 5 Knives with wear coating
- 6 Cover for deflector mounting
- 7 Small disc scraper
- 8 Scraper with deposit welding

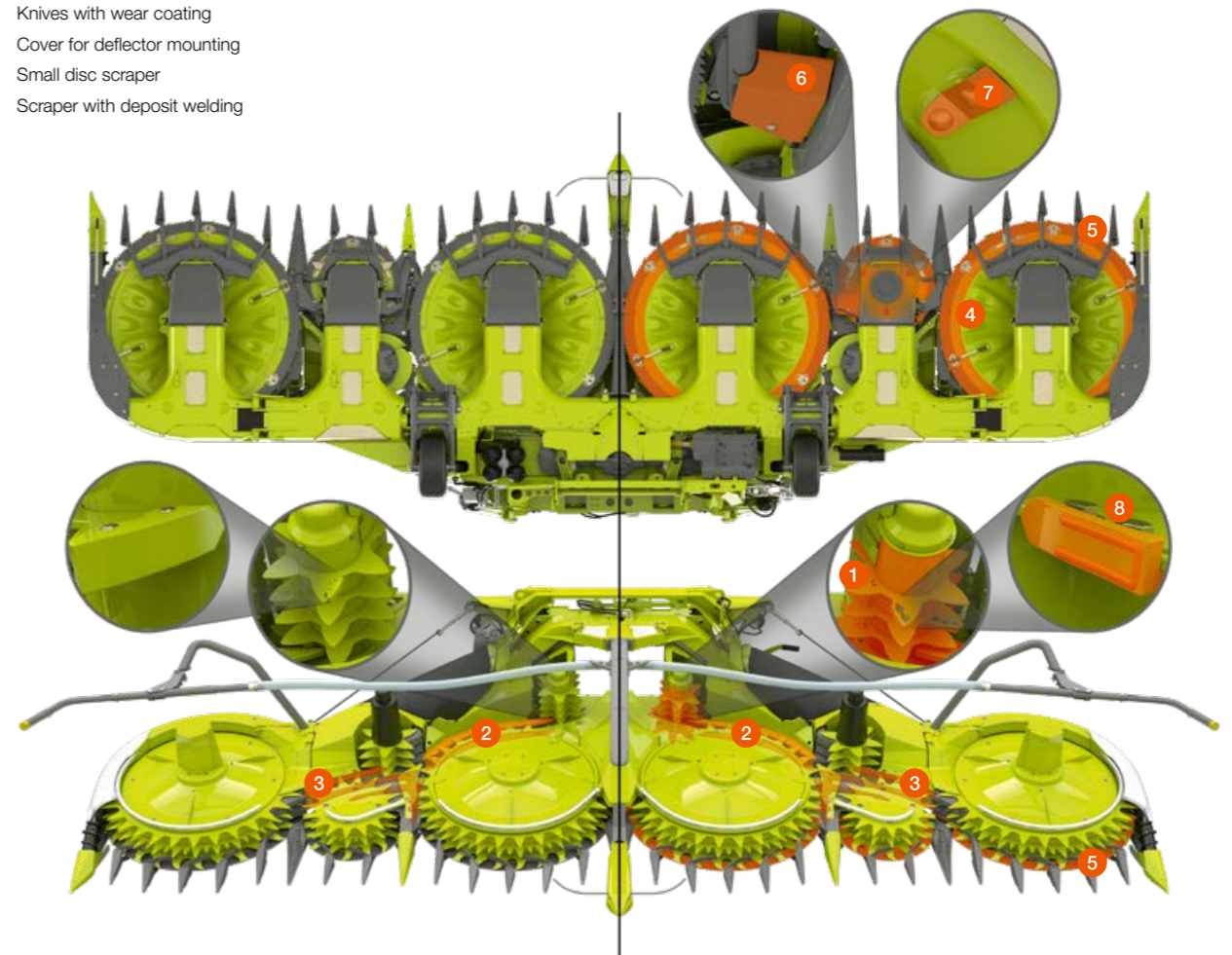

CLAAS PREMIUM LINE	Advanced	Professional
1 Feed roller toothed bars	–	●
2 Smooth roller stripper bar	●	●
3 Chopping cylinder concave	●*	●*
4 Vanes	●*	●*
5 Grass chute back panel	●*	●*
6 Accelerator paddles	–	●
7 Accelerator housing, 2-part	–	●*
8 Accelerator housing, left /right sides	–	●*
9 Accelerator back panel	●*	●*
10 Lower discharge chute plate, front / rear	●*	●*
11 Discharge spout rotation ring plate	●*	●*
12 Wear plates of discharge spout	–	●*
13 First wear plate on discharge spout	–	●
14 Discharge spout flap	–	●

* The JAGUAR PREMIUM LINE Advanced and Professional packages give you a guaranteed operation warranty on all parts marked with*. This cover runs for five years or for a specified number of engine operating hours (whichever limit is reached first). For the precise number of hours, please see the JAGUAR product page which can be reached using the QR code above. Only available for selected countries.

● Available – Not available



- 1 CEBIS with touchscreen
- 2 Steering column adjustable three ways
- 3 Comfortable armrest with integrated switches for direct adjustment
- 4 CMOTION control lever with access to favourites management
- 5 6-step chop length transmission
- 6 V-CLASSIC for high throughput
- 7 MULTI CROP CRACKER MAX with Busa®CLAD coating
- 8 PREMIUM LINE crop flow parts for a long service life
- 9 ACTISILER 37 highly concentrated silage additive system with insulated tank
- 10 NUTRIMETER to determine dry matter and constituents
- 11 AUTO FILL side and rear with display symbol for discharge spout position
- 12 Emission standard Stage V
- 13 CRUISE PILOT automatically ensures the machine makes maximum use of the set engine load
- 14 Mechanical four-wheel drive
- 15 Automatic transport protection for ORBIS maize front attachment
- 16 GPS steering system CEMIS 1200
- 17 Water injection to clean the crop flow
- 18 NEW: AUTO FILL with trailer changeover

Parts and services?

**Everything, at
the right time.**

We're here for you – together, we can achieve the best possible results.

Keeping you operational is the top priority for CLAAS. With our comprehensive service, parts and consumables, we ensure that your machines can always deliver optimum performance.

Our support includes a wide range of maintenance and repair services available from your dealer, an extensive line-up of ORIGINAL parts and consumables as well as digital tools which support your planning and decision-making. Confidence comes from knowing you are always ready for action.

Fully covered with MAXI CARE service agreements.

MAXI CARE gives you all-round cover for repairs and maintenance. A comprehensive range of packages ensures that your machines are always ready for action, allowing you to focus fully on your core tasks. CLAAS offers four MAXI CARE service agreements tailored to the needs of your business.



Impressive advantages.



Crop flow.

- The crop flows in a straight line through the entire machine without any awkward angles
- Robust feeder unit for perfect crop flow
- V-CLASSIC chopping cylinder for optimal quality of chopped material
- Modular discharge spout enables reliable crop transfer up to a working width of 7.5 m
- Silage additive app makes it easy to use silage additives appropriately
- Water injection keeps the crop flow clean

CLAAS POWER SYSTEMS.

- The CLAAS drive system achieves the highest degree of efficiency in market comparisons
- JAGUAR 880 with up to 653 hp as top-of-the-range model in the 800 series
- Higher engine output for the JAGUAR 860 with up to 490 hp
- 11% increase in tractive power for improved traction

Comfort and convenience.

- Increased cab comfort with gooseneck microphone, DAB+ radio, compressed air cleaning hose in the cab and more
- Spacious comfort cab with low noise level and optimal visibility and lighting
- Quick and easy access to all machine functions via the CEBIS touchscreen
- Key functions can be adjusted directly with armrest switches
- Favourites management can be operated conveniently by means of the CMOTION control lever
- LED work lights with characteristics similar to daylight are positioned on the roof, rear and discharge spout to enable an excellent overview of machine operations

Operator assistance systems.

- CEMIS, the satellite-based steering system
- CRUISE PILOT increases driving comfort and efficiency while reducing fuel consumption
- AUTO FILL and OPTI FILL avoid losses when transferring the harvested material
- Transfer from one field to the next without having to get down from the cab thanks to the automatic transport protection for the ORBIS 750 / 600 / 600 SD
- AUTO FILL with trailer changeover while on the move

JAGUAR	880*	870	860	850	840
Engine					
Manufacturer	Mercedes-Benz	Mercedes-Benz	Mercedes-Benz	Mercedes-Benz	Mercedes-Benz
Type	OM 473 LA	OM 473 LA	OM 471 LA	OM 471 LA	OM 471 LA
Cylinders	S6	S6	S6	S6	S6
Displacement	l 15.60	15.60	12.80	12.80	12.80
Engine output (ECE R 120)	kW (hp) 480 (653)	430 (585)	390 (530)	340 (462)	320 (435)
Engine speed at maximum output (ECE R 120)	rpm 1600	1600	1600	1600	1600
SCR exhaust gas aftertreatment, Stage V	●	●	●	●	●
Fuel tank (standard) + auxiliary tank (option)	l 1000 + 300	1000 + 300	1000 + 300	1000 + 300	1000 + 300
HVO ready	●	●	●	●	●
Urea tank	l 130	130	130	130	130
Fuel consumption measurement	○	○	○	○	○
Chassis					
Ground drive: 2-speed transmission, automatic OVERDRIVE (hydrostatic)	●	●	●	●	●
Steering axle, standard	●	●	●	●	●
Steering axle, 3 x adjustment, distance btw. axle flanges (wheel mounting face), 2470 / 2930 / 3090 mm	–	–	–	–	–
Driven steering axle, POWER TRAC, mechanical	○	○	○	○	○
Water / silage additive tank, content 375 l	●	●	●	●	●
Silage concentrate system, ACTISILER 37, capacity 37 l	○	○	○	○	○
Front attachments					
ORBIS 750 / 600 SD / 600 / 450, working width 7.45 / 6.04 / 6.01 / 4.48 m	○ ORBIS 750 / 600 / 450	○ ORBIS 750 / 600 / 450	○ ORBIS 750 / 600 / 450	○ ORBIS 600 / 450	○ ORBIS 600 / 450
PICK UP 380 / 300, working width 3.60 / 2.62 m	○	○	○	○	○
DIRECT DISC 600 P / 600, working width 5.96 m	○	○	–	–	–
DIRECT DISC 500 P / 500, working width 5.13 m	○	○	○	○	○
Front attachment drive					
Mechanical via quick-release coupler	●	●	●	●	●
Hydraulic reversing	●	●	●	●	●
Feeder unit					
Width 730 mm	●	●	●	●	●
Feed and pre-compression rollers, no.: 4	●	●	●	●	●
Mechanical precompression	●	●	●	●	●
Chopping cylinder					
Width 750 mm	●	●	●	●	●
Diameter 630 mm	●	●	●	●	●
Revs at rated speed 1200 rpm	●	●	●	●	●

JAGUAR	880*	870	860	850	840
V-CLASSIC knife configuration					
V20 (2 x 10), LoC 6 / 8 / 11 / 14 / 18 / 22 mm	○	○	○	○	○
V24 (2 x 12), LoC 4.5 / 6.5 / 9 / 12 / 15 / 18 mm	○	○	●	●	●
V28 (2 x 14), LoC 4 / 5.5 / 7.5 / 10 / 13 / 15.5 mm	●	●	○	○	○
Automatic knife sharpening from cab	●	●	●	●	●
Automatic adjustment of shear bar from cab	○	○	○	○	○
MULTI CROP CRACKER					
INTENSIV CRACKER M, ø 196 mm	●	●	●	●	●
MCC CLASSIC M, ø 196 mm	○	○	○	○	○
MCC CLASSIC L, ø 250 mm	○	○	○	○	○
MCC MAX, ø 265 mm	○	○	○	○	○
MCC SHREDLAGE® M, ø 196 mm	–	–	–	○	○
MCC SHREDLAGE® L, ø 250 mm	○	○	○	○	○
Crop accelerator					
Width 680 mm	●	●	●	●	●
Diameter 540 mm	●	●	●	●	●
Mechanical clearance setting	○	○	○	○	○
Discharge spout					
Collision protection	●	●	●	●	●
210° swivel angle	●	●	●	●	●
Swivel angle with OPTI FILL / AUTO FILL 225°	○	○	○	○	○
Operator assistance systems					
AUTO PILOT, central sensors (maize)	○	○	○	○	○
CAM PILOT swath tracking guidance (grass)	○	○	○	○	○
GPS PILOT	○	○	○	○	○
STOP ROCK, stone detector	○	○	○	○	○
QUANTIMETER, throughput measurement	○	○	○	○	○
OPTI FILL, optimised spout control	○	○	○	○	○
AUTO FILL, automatic trailer filling	○	○	○	○	○
NUTRIMETER, measurement of dry matter and constituents	○	○	○	○	○
DYNAMIC POWER	○	○	○	–	–
CRUISE PILOT	○	○	–	–	–
Machine connect licence – 5 years	●	●	●	●	●
Job management	○	○	○	○	○
Yield mapping	○	○	○	○	○

*JAGUAR 880 only for selected markets

JAGUAR	880*	870	860	850	840
--------	------	-----	-----	-----	-----

Cab					
CEBIS with touchscreen	●	●	●	●	●
A/C-MATIC air conditioning	○	○	○	○	○
Printer	○	○	○	○	○
Comfort seat	○	○	○	○	○
Swivelling seat	○	○	○	○	○
Premium seat, ventilated, heated	○	○	○	○	○
Leather seat, ventilated, heated	○	○	○	○	○
Standard seat	○	○	○	○	○
Instructor's seat	○	○	○	○	○

Noise and vibration levels					
Equivalent continuous A-weighted sound pressure level measured in various operating states, as per ISO 5131	dB (A)			71 ¹	
Vibration total value, as per standard EN 1032:2003	m/s ²			≤ 2.5 ¹	
Effective value, as per standard EN 1032:2003	m/s ²			≤ 0.5 ¹	

Maintenance					
Central lubrication system, 8-litre lubricant reservoir		○	○	○	○
Maintenance lighting		○	○	○	○

Dimensions and weights					
Working length	mm	6495	6495	6495	6495
Working height with discharge spout extension L	mm	5450	5450	5450	5450
Transport height	mm	3897	3897	3897	3897
Transport length with discharge spout extension L	mm	8015	8015	8015	8015
Transport width with drive axle tyres					
800 model	m	3.30	3.30	3.30	3.30
710 model	m	3.20	3.20	3.20	3.20
650 model	m	3.00	3.00	3.00	3.00
Weight without front attachment with standard tyres ²	kg	11550	11550	11150	11050

¹ Detailed information about the values can be found in the corresponding operator's manual

² V-CLASSIC 24, standard crop flow, discharge spout extension M, without rear ballast, diesel and urea tanks empty

*JAGUAR 880 only for selected markets

● Standard ○ Option □ Available – Not available

We want to make you the best in your field.

In everything we do, the focus is on you, our customers. We understand your daily challenges. Together with you, we develop agricultural technology ensuring you can farm successfully and sustainably today and in the future. Our digital solutions simplify complex processes and make your work so much more convenient.

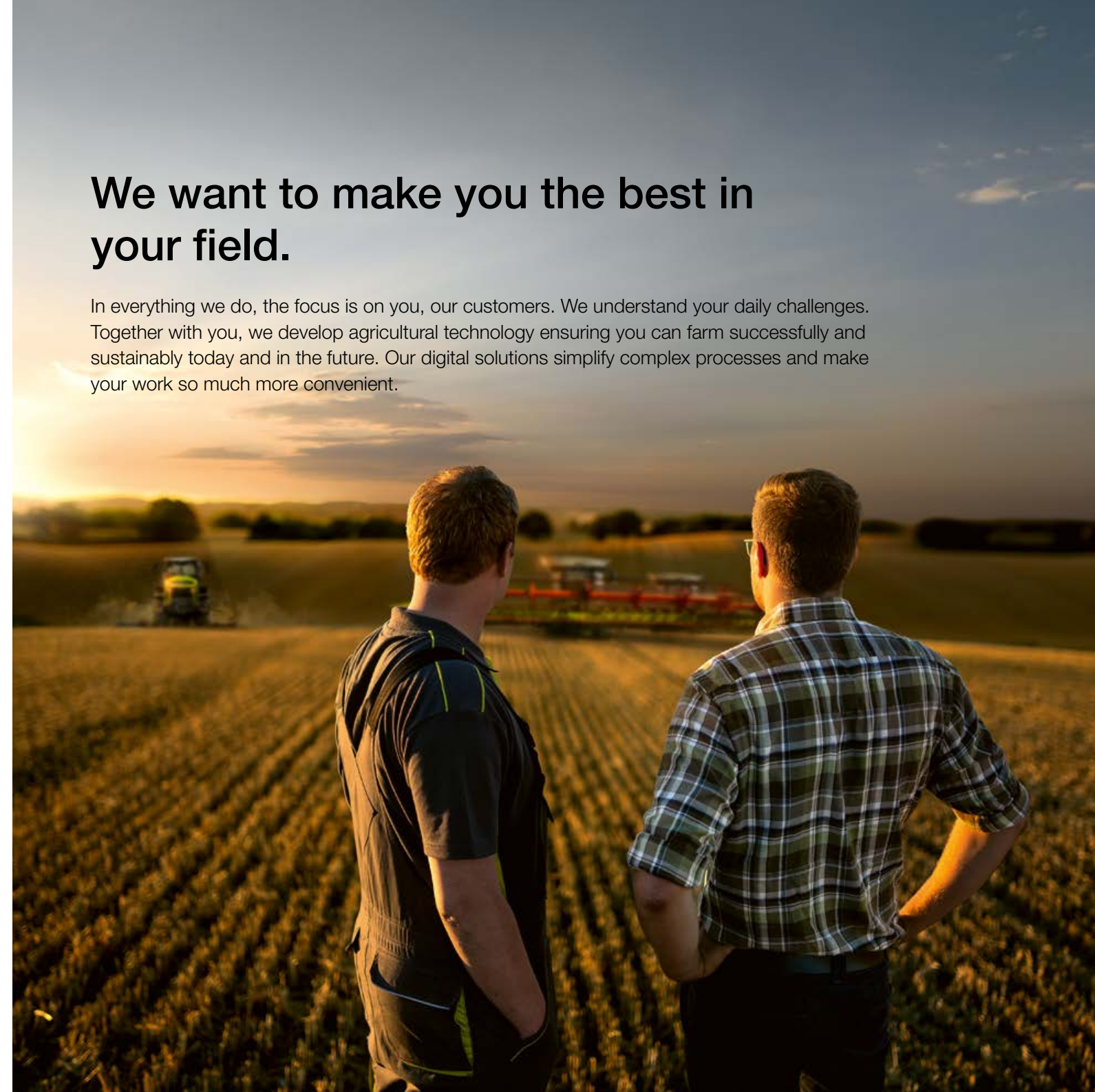

CLAAS KGaA mbH
Mühlenwinkel 1
33428 Harsewinkel
Deutschland
Tel. +49 5247 12-0
claas.com

HRC / 202012001111 NO LC 0126